



Mountain catalog

2026 - 2027

5 SEGMENTS:



SIGNAGE



SAFETY



COMPETITION



LEISURE



FACILITIES

Contents

MBS MOUNTAIN CATALOG 2026 - 2027



SERVICES
P.6-11

1



SIGNAGE
P.12-57

2



SAFETY
P.58-121

3



COMPETITION
P.122-147

4



LEISURE
P.148-199

5



FACILITIES
P.200-209

Presentation



SIGNAGE



MBS offers an extensive range of bespoke, customized and digital signage solutions. Our latest-generation design workshop is capable of addressing all needs for rugged, high-definition signage on a variety of media, including wood, polycarbonate, Dibond, paper and stickers. Drawing on its longstanding expertise in developing and fitting out ski areas, MBS designs and installs all the necessary signage, especially for ski runs and MTB trails.

SAFETY



Safety is the core business at MBS. Following its creation in the 1990s, the company began producing crash pads before branching into banners, ski trail signs and rescue toboggans. Capitalizing on its long track record in the sector, MBS is focused on providing an end-to-end range of solutions to fulfil the needs facing ski area operators. Our production workshops in south-eastern France guarantee durable products of the highest quality. MBS also works alongside such renowned brands as Ortovox, Mammut, Tyromont and Petzl to round off its already comprehensive range. Our high-level safety expertise is reflected in our consulting services and our ability to design, supply and install safety netting for FIS-approved ski trails, as well as golf courses and driving ranges.

COMPETITION



MBS began making inroads into the Competition segment back in the 2000s, starting with solutions to improve safety, such as installing FIS A-approved netting, before supplying equipment for sports clubs, ski clubs and ski schools. MBS is the only French brand for FIS-approved flex poles. The company also provides an array of locally manufactured products, as well as HC Timing and ALGE timing systems. To keep pace with our customers' ever changing needs, MBS has developed such innovative products as the Crossgrip brush grip base for WORLD CUP and MAGIC poles, as well as crash pads (Airpads) featuring an intelligent pressure control system. With an enduring legacy and steadfast commitment to the alpine skiing sector, MBS is also a key technical partner to top-tier sports events, including the FIS Alpine Ski World Cups. MBS has also maintained long-term partnerships with the Savoie Skiing Committee, as well as sports clubs in Val Thorens, Val d'Isère, Courchevel, Méribel and Valloire.

LEISURE



We design sports, recreational and outdoor activities. Our Leisure division can harness the company's extensive manufacturing expertise and our new dedicated design service. MBS allows professionals to stand out from the competition with an identity marketing strategy using unique theme-based trails and play areas offering original and innovative experiences. With their design and the stories they tell, these solutions create moments of unbridled pleasure that not only leave everlasting memories, but are also widely shared over social media.

FACILITIES



We are focused on our mission of designing and implementing effective, leading-edge solutions geared towards ski resort operators' specific needs. We offer an extended collection of anchoring and snow retention systems, including netting and barriers, as well as such facilities and infrastructure as rope-based surface lifts and conveyor belts. We provide the accessories that play a vital role in a ski resort's day-to-day operations, encompassing both its ski areas and its road network. We can draw on our expertise to improve ski resort safety and efficiency, meaning that our customers can maximize their potential while enhancing their user experience.

Editorial



Dear Customers and Partners,

Here at MBS, it gives us an immeasurable sense of pride to present our new catalog, which symbolizes the company's new driving force. After several years without getting an update, this catalog reflects our determination to inject new energy into our product range and deliver an even greater response to your specific needs and expectations. The teams at MBS are firm believers in promoting a mountain industry that embraces sustainability and innovation.

Empowered by our expertise in designing and supplying products and accessories for ski areas, improving safety on the slopes and during major sports events, and addressing the needs for the outdoor activities, recreational sports and golf sector, we can provide a wealth of bespoke solutions that not only supercharge performance, but are also kind to the environment. Innovation, quality and sustainability are the cornerstones of the MBS product range, which are further strengthened by our CSR commitments.

Our strategic vision for the years ahead guides our every action, while ensuring that our customers and their satisfaction are always at the top of our priority list.

Based on our clear insight into your specific challenges, we will work alongside you as true partners to address those challenges using a vast selection of products that have been designed and manufactured in the very heart of the French Alps, which can set your company on the road to operational excellence and greater responsibility.

You can count on the teams at MBS for their unwavering support, passion and expertise in working together to build a daring and sustainable future in line with your specific requirements.

Thank you for your ongoing trust. Let's work together in transforming each summit into a joint success story.

Happy reading!

Fred LAHAYE-GOFFART
General Manager





*"MBS –
your partner for
a sustainable and
innovative mountain
industry."*



About us



VISION

MBS, a world-class player in designing and providing facilities and infrastructure for ski areas, provides ski area operators with innovative, top-quality solutions tailored to their changing needs and expectations.



VALUE

Headquartered in Tours (south-eastern France) since 2007, MBS boasts a strategic vantage point near some of the world's most renowned ski resorts. We have carved a reputation for our wide product range specifically designed for professionals in the sports, mountain and leisure industries. Our company's values are reflected in our small, yet agile team through their ability to promote creativity, deliver a fast response and ensure maximum availability. Our expertise includes consulting services as well as the design, manufacture and installation of bespoke solutions using our modern, high-performance production facilities.



MBS founded by Vincent GALLOT-LAVALLÉE



Takeover of Adic-Gespi to develop the company's mountain activities



Takeover of JC Dalloz to expand the competition range

MBS
HISTORY

1994

2005

2010

1999

2006

2011



Company taken over by **Xavier GALLOT-LAVALLÉE** at the age of 18



MBS and TAS business activities combined in Savoie



Takeover of a company in Eagle (Vail), Colorado, for **Made in USA** products



Xavier GALLOT-LAVALLÉE

Chairman & CEO of MND

Ever since the company was founded, MBS has continually grown to become a leading force in the ski area safety and infrastructure market.

We have never been more focused on our ambition of rolling out groundbreaking solutions on a global scale, while taking steps to protect our environment.

This catalog paints a clear picture of our commitment to bring greater performance, sustainability and safety to an ever changing mountain world.

Our team is ready and waiting to tackle the challenges of tomorrow with the same determination to best serve our customers and deliver the highest quality.

I hope that you enjoy reading this catalog.



SERVICE

MBS offers a wide range of safety, competition, signage, fit-out and competition equipment. Every product is designed and manufactured in-house to guarantee the ultimate quality and reliability. We believe in providing an end-to-end service, from design through to installation, with the aim of addressing the specific needs facing ski areas and enhancing customer satisfaction.



Takeover of Secomate and relocation of MBS's business activities to Tours (south-eastern France)

2013



Creation of an office in **Laconia, New Hampshire**, to cover Central and Eastern USA

2015



Launch of **summer ranges** and inroads into new sectors (including the urban sector)

2021

2015



Launch of a dedicated range of protection products for **golf**

2020



Takeover of h.o.5.park to diversify the recreational products, and launch of the joinery workshop

2024



23 employees in France and 9 employees in the USA (year-round)

Teams



Our technical facilities are divided into **workshops:**



JOINERY



METALWORK



SIGNAGE



PADS



SEAM WORK



PAINTING

Our teams feature **32 people** (year-round) with the necessary expertise to successfully lead your projects and facilities, including qualified operators for radio-frequency welding, seam work, steel welding, woodworking, painting, CNC machining for different types of media, printing, bonding, and so on, as well as logistics agents, a planner, account managers trained on the company's project management processes, and a dedicated customer care and sales team, without forgetting the MND Group's support services (IS, HR, MKT, FI, etc.).



Our environmental policy

Choosing the products in the MBS range is a clear way of showing that your company values sustainability, innovation and high quality. Let's work together in building a more responsible future for our ski resorts and the planet. At MBS, we are committed to ensuring that every decision brings us one step closer to a green and fairer world.



In 2024:
90% of purchases were made
 in **Europe**, with **60%** in **France**



MBS has chosen 4 of the UN's 17 Sustainable Development Goals to form the backbone of its CSR policy:



Industry, innovation and infrastructure:

At MBS, quality is a focal part of our mission. Our equipment is designed to stand the test of time, with rugged materials and options for maintaining and repairing our products. Every day, we are committed to delivering high-performance, innovative and sustainable solutions to meet our customers' specific needs.



Responsible consumption and production:

We select materials with a lower impact on the environment, and we prioritize local, ethical suppliers. We have reengineered our processes and production methods for greater energy efficiency. At every level within the company, MBS has adopted responsible practices for using, purchasing and developing its products and digitizing its processes, with the goal of creating a pathway towards a more environmentally friendly future.



Reduced inequalities:

At MBS, combating inequality is a core value, which includes such issues as gender inequality, inclusion, quality of working life, and access to quality education. Every cause is important and deserving of active support. MBS hires workers from the local area and strives to foster an inclusive work environment where everyone can fulfil their potential.



Life on land:

Protecting nature and biodiversity are top priorities at MBS. Aware of its responsibility towards the environment, the company is actively involved in a number of initiatives where performance and sustainability go hand-in-hand.

Examples of tangible initiatives in 2024:

- **Carbon footprint** assessment
- Map showing the **origin of MBS's suppliers**
- **Carbon footprint measured** for business travel (air, rail, company cars, hotels, etc.)
- **Short supply chains** created, and **materials recycled and reused**
- Implementation of a **process for recycling** material offcuts



[Find out more](#)

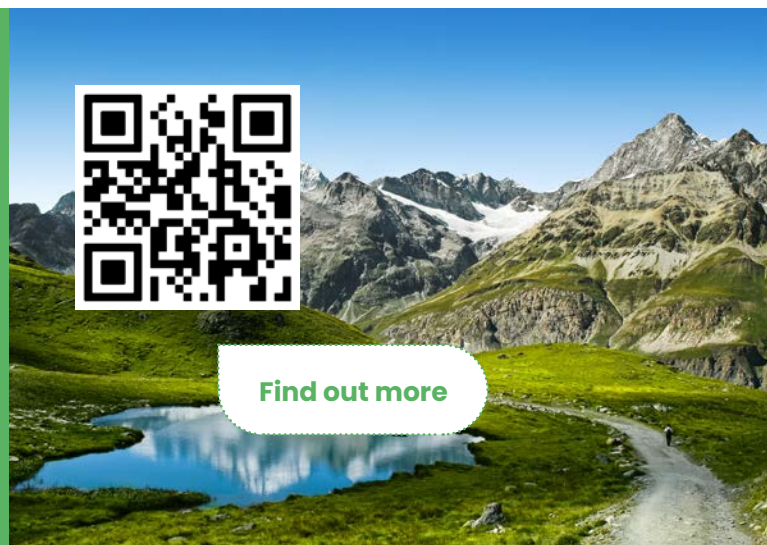

PROOFING

Let our teams
customize your media!



ID	Proofing type	Customer approval	Level of customization	Price
	Proofing without a signature	None	+	+
Z0103	Proofing service*	Up to two adaptations before the final proof	++	++
Z0104	Graphic design service*	Up to two adaptations before the final proof	+++	+++++
Z0175	Logo vectorization*	None	None	+

*Note: the order will be sent to production after the signed final proof has been received

Proofing without a signature

Our teams customize the text on your standard signs or banners for you. You define the required standard sign / banner.

- You define the required text.
 - We customize the chosen text on the sign / banner (custom colors and fonts are not included).
 - We create the proof in-house, so that the order can be cleared for production without requiring your signature.
- The proofs already in our database will also be sent straight to production without requiring your signature.

Z0103 Proofing service

Our teams customize the dimensions of your signs or banners, subject to compatibility with our production technologies.

- You define the required standard sign / banner, and we customize the dimensions together.
- You define the required text.
- You provide us with a copy of your logo in an editable format (AI, EPS or PDF).
- Together, we define the custom elements: colors, logo (created by you), pictogram (created by you) and fonts.
- Our teams can customize the medium for you by offering **up to two visual adaptations** based on our standards. Another proofing service will be charged if more than two adaptations are required.
- If you wish to create the artwork for your sign / banner yourself, we will provide you with the templates.
- We create and send the final proof to you for signing before the order is cleared for production (your signature is required).

Z0104 Graphic design service

For your various projects, whether fun runs, signage or sports circuits, we can create all types of graphics without any prerequisites.

Z0175 Logo vectorization

If your logo is not in an editable format, we can vectorize the logo based on your image file.

Your advantages with **MBS**

Extra benefits with MBS: unique expertise
and everyday commitment

Pre-season orders

Between April **1** and **June 30**, get 10% off
all the product references in the catalog!

-10%



Anticipate your servicing and replacement cover needs!

To schedule our production activities and ensure the best lead-times, please anticipate your servicing and replacement cover needs between April **1** and **July 30**. We reserve the right to refuse any orders outside this period. Products concerned:

- Replacement covers for safety or recreational crash pads
- Avalanche transceiver repairs / updates
- Servicing for MBS rescue toboggans



E-shop

Find all our catalog products in our e-shop: simply add them to your cart and then order online.

So quick and easy!

www.mbs.fr



Clearance deals

We offer clearance deals on several items throughout the year on our website!

www.mbs.fr/314-destockage



up to
50%
off



Standard terms and conditions of sale

www.mbs.fr/content/3-conditions-generales-des-ventes



12



Signage

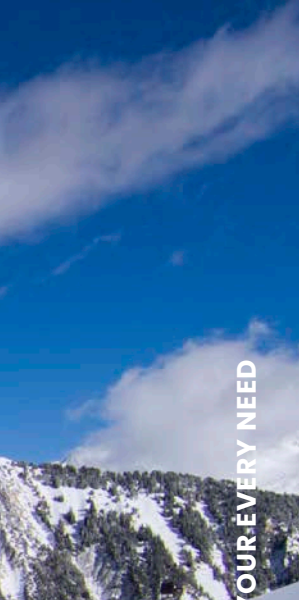

◆ MBS: BEST-FIT SOLUTIONS FOR YOUR EVERY NEED



Standard banners	P. 14
Customizable banners	P. 22
Queue management	P. 24
Signage	P. 26
Custom signs	P. 48
Check out our workshops	P. 50
Customizable banner flags	P. 52
Totem signs, panels and arches	P. 54
LED screen and panel signage	P. 56

Standard banners



Horizontal banners

Customizable Slow and Danger banners

High-visibility PVC openwork mesh banners (W 2.00 m - H 0.50 m) mounted using bungee cords on 2 fiberglass poles (H 1.50 m)



Any questions?
Call our MBS experts

- ◆ CHOOSE YOUR PICTOGRAM
- ◆ CHOOSE YOUR BANNER
- ◆ SPECIFY THE IDS

01.

Choose your pictogram



PICTO A



PICTO B



PICTO C



PICTO D



PICTO E



PICTO F

02.

Choose your banner with a customizable pictogram from the languages available

LANGUAGES



BAN101_



BAN103_

or

LANGUAGES



BAN101E_



BAN103E_

03.

Specify the ID

Add the letter corresponding to the required pictogram after the ID of the chosen banner:
Refer to the examples below



BAN103



PICTO A



BAN103A



BAN101E



PICTO B



BAN101EB





Horizontal banners

Standard (non-customizable)

2 m x 0.50 mounted on 1.50 m poles

LANGUAGES



BAN102

or

LANGUAGES



BAN102E



BAN100



BAN154



BAN155



BAN156



BAN158



BAN191



BAN218



BAN122



These banners can be adapted based on a proof that does not require your signature. Contact us to find out more.



Check out the Snowpark banners on page 31.

Standard banners



Vertical banners

Customizable Slow and Danger banners

High-visibility PVC openwork mesh banners (W 0.50 m - H 1.00 m) mounted using bungee cords on 2 fiberglass poles (H 1.75 m)



Any questions?
Call our MBS experts

- ◆ CHOOSE YOUR PICTOGRAM
- ◆ CHOOSE YOUR BANNER
- ◆ SPECIFY THE IDS

01.

Choose your pictogram



PICTO A



PICTO B



PICTO C



PICTO D



PICTO E



PICTO F

02.

Choose your banner with a customizable pictogram from the languages available

LANGUAGES



or

LANGUAGES



BAN107_



BAN108_



BAN107E_



BAN108E_

03.

Specify the ID

Add the letter corresponding to the required pictogram after the ID of the chosen banner:
Refer to the example opposite



BAN107 + PICTO A

BAN107A





Vertical banners

Standard (non-customizable)

0.5 m x 1 m, mounted on 1.75 m poles

LANGUAGES



BAN140

LANGUAGES



BAN140E



signage

safety

competition

leisure

facilities



These banners can be adapted based on a proof that does not require your signature. Contact us to find out more.

Standard banners



Chevron directional banners

High-visibility PVC openwork mesh banners, H 0.30 m, mounted using bungee cords on several fiberglass poles, H 1.50 m

FRONT



Fluorescent orange version

Visual: chevrons pointing right

< m >	Direction	Poles	ID
2 m	> > >	x2	BAN123D
4 m	> > >	x3	BAN124D
6 m	> > >	x4	BAN126D
8 m	> > >	x5	BAN131D
10 m	> > >	x6	BAN132D
4 m	<<<>>>	x3	BAN169

bi-directional chevrons



Blue version

Visual: chevrons pointing right

< m >	Direction	Poles	ID
2 m	> > >	x2	BAN194D
4 m	> > >	x3	BAN195D
6 m	> > >	x4	BAN196D
8 m	> > >	x5	BAN197D
10 m	> > >	x6	BAN198D
4 m	<<<>>>	x3	BAN203

bi-directional chevrons



Fluorescent orange version

Visual: chevrons pointing left

< m >	Direction	Poles	ID
2 m	< < <	x2	BAN123G
4 m	< < <	x3	BAN124G
6 m	< < <	x4	BAN126G
8 m	< < <	x5	BAN131G
10 m	< < <	x6	BAN132G



Blue version

Visual: chevrons pointing left

< m >	Direction	Poles	ID
2 m	< < <	x2	BAN194G
4 m	< < <	x3	BAN195G
6 m	< < <	x4	BAN196G
8 m	< < <	x5	BAN197G
10 m	< < <	x6	BAN198G



FRONT • BACK



Fluorescent orange version

Visual: chevrons pointing left on one side and pointing right on the other

< m >	Direction	Poles	ID
2 m		x2	BAN228
4 m		x3	BAN229
6 m		x4	BAN230
8 m		x5	BAN231
10 m		x6	BAN232
4 m	<<<>>>	x3	BAN237

bi-directional chevrons

MBS EXPERT'S TOP TIP
the two-sided version can be used in both directions



On the two-sided version, the chevrons are not perfectly aligned during printing.

signage

safety

competition

leisure

facilities

signage

Standard banners



Vertical frame banners

Banner, W 0.80 m - H 1.50 m, mounted on a frame, W 0.80 m - H 2.00 m. Ø 30 mm poles. Corners assembled with clips.



Type	One-sided	Two-sided
Openwork mesh	BAPV00149	BAPV00149V
Digitally printed PVC canvas	BAN146	BAN146V



Fabric banners on request

Horizontal frame banners

Banner, W 2.00 m or 3.00 m - H 1 m, mounted on a frame, W 2.00 m or 3.00 m - H 1.30 m. Ø 30 mm poles. Corners assembled with clips.



Type	L x H m	One-sided	Two-sided
Digitally printed PVC canvas	2x1	BAN270	BAN270V
	3x1	BAN147	BAN147V
Openwork mesh	2x1	BAPV00190	BAPV00190V
	3x1	BAPV00191	BAPV00191V



Finish line banners

Overhead finish line banners made from 350 gsm micro-perforated mesh (custom dimensions on request), 6 m x 0.60 m, with nylon rope and stiffeners.

BAPV00001



Proofing explanations and details on page 10



Contact us for any special requests. We would be only too happy to offer our support in organizing your events.



On steel frames

0.80 m x 1.20 m

A lightweight, stable, portable and wind-resistant banner frame for your ad hoc signage needs. Compatible with two-sided banners! Can be installed on the roadside, on the snow or on natural terrain.

Vertical banners can be mounted on frames that are fitted to snow cannon bases or anchored to the ground.

High-visibility PVC openwork mesh banners, W 0.50 m - H 1.00 m, mounted using bungee cords on a frame, W 0.80 m - H 1.20 m



Frame

FOMEMS023



Ø 80 clamp

FOMEMS010



Ø 100 clamp

FOMEMS011



Oval clamp

FOMEMS009

Accessories



Adjustable attachment (per 50), Ø 16 mm

ACC118



Drive head (per 50)

ACC159



TENSION bungee

ACC106



Fiberglass pole with a drive head, an adjustable attachment and 2 tension bungees

Ø 16 mm, H 1.50 m

PIQ124

Ø 16 mm, H 1.75 m

PIQ125

Customizable banners



Need a custom banner? Easily get a quick quote with our new model! Customize your banners by selecting the print type, height, length and type of banner, as shown in the examples below, to define the MBS ID number!



BANMULTIH30J6



BANUNIH50B2



BANMULTIH50J2



BANMULTIV100R5



BANUNIV100O5



BANUNIH30O4



BANNUMH30N6



BANMULTIH30R10



BANMULTIH50J8

These banners can be adapted based on a proof that does not require your signature.
Contact us to find out more.



How do you define your custom banner?

High-visibility openwork mesh banners mounted using bungee cords on 2 fiberglass poles

Define your MBS ID according to this model:

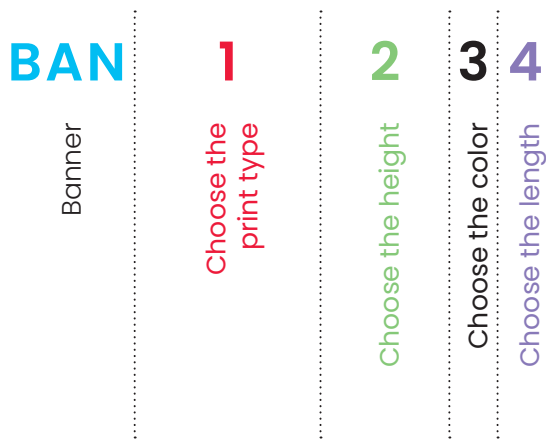

MBS ID example



Proofing explanations and details on page 10



Customize your queue management banners on page 24



Can't find what you're looking for? Get in touch, and we'll define your bespoke project.

01. Choose the print type



Single-color printing



Multi-color printing



digital printing

03. Choose the color



Blue openwork mesh, white writing, blue PVC canvas border



Red openwork mesh, white writing, red PVC canvas border



Orange openwork mesh, black writing, black PVC canvas border



Yellow openwork mesh, black writing, black PVC canvas border



Digital printing, white border on the back

02. Choose the height

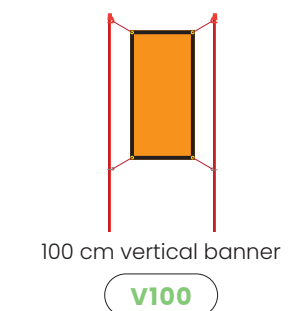
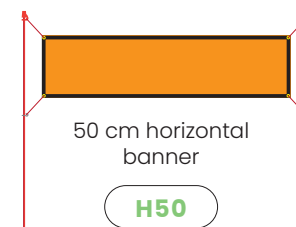
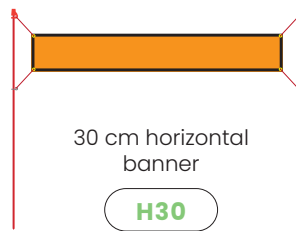

04. Choose the length

2 Lg 2m

4 Lg 4m

6 Lg 6m

8 Lg 8m

10 Lg 10m

5 Lg 0,5m

signage

safety

competition

leisure

facilities

signage

Queue management



Queue management banners

Choice of colors 

With or without markings. Custom markings available.

Choice of dimensions: height 30 cm, 50 cm or 70 cm, custom lengths.

On fiberglass poles

You can easily design your custom banners using our new model on page 22-23. Feel free to contact us to discuss your needs.



On cable-based systems

Discuss your needs with our experts. We design your cable-suspended custom banners for different fixing systems, including tensioners, springs, links, with or without stiffeners, with or without reels, and so on.



Check out our reels on page 120



Proofing explanations and details on page 10



Queue barrier posts

Treated timber post
Class IV - Ø 80 mm - H 1200 mm
+ 350 mm galvanized steel post support spike

BAR117



Queue barrier ropes

Ø 24 mm - L 3 m

BAR119



BAR120



Rope

Ø 24 mm rope
in 100 m rolls

COR157



COR160



253587



TEFLON END CAP
with a ring

COM378



TEFLON END CAP
with a ring and chain
+ 2 screw links

DIV524



QUICK LINK
8 mm

ACC129



signage

safety

competition

leisure

facilities



Signage Accessories

-

Discover a wide range of signage solutions. The most common products are presented on these pages, but we also offer customized solutions. Feel free to share your project with our experts, who will guide you toward the options best suited to your needs.

Clamps

Supplied with fasteners

For markers in PC and Dibond

Complete ABS clamp
(2 brackets with fasteners)



Tube Ø40

SIG114

Tube Ø50

SIG249

Tube Ø60

SIG250

For markers in aluminum

1 steel bracket with fasteners
(Allow 2 units for 1 sign)



Tube Ø40

SIG111

Tube Ø50

SIG112

Tube Ø60

SIG113

Single bracket
without fasteners

COM321A

Adjustable clamps for markers



SIG259



Pole Ø80

SIG264

Pole Ø100

SIG266



Aluminum tubes for signs

Tube Ø40

SIG105

Tube Ø50

SIG106K

Tube Ø60

SIG107

3 m



Find the polycarbonate stakes
on page 100

signage



Signage MTB

Signs available in different materials

ABSXXX polycarbonate



Steep slope

ABS357



MTB jump

ABS370



MTB crossing

ABS369



MTB bump

ABS358



MTB hazard

ABS359



MTB trail narrows

ABS371



Ramp

ABS617



Teeter totter

ABS618



Double bump

ABS619



MTB bridge

ABS620



Jump

ABS621



Whoops

ABS622



RALENTIR



Other visuals are available on request



Exit lane on the left

ABS348



Exit lane on the right

ABS349



Stopping allowed on the left

ABS350



Stopping allowed on the right

ABS351



MTB trail start

ABS352



MTB trail end

ABS368



Red MTB trail sign

ABS353



Blue MTB trail sign

ABS354



Green MTB trail sign

ABS355



Black MTB trail sign

ABS356



MTB trail start

ABS379

PRODUCT CUSTOMIZABLE

MBS EXPERT'S TOP TIP
Send us the numbers, trail name and logo



Red MTB arrow

ABS344



Blue MTB arrow

ABS346



Green MTB arrow

ABS345



Black MTB arrow

ABS347

MBS EXPERT'S TOP TIP
Send us the arrow direction, trail name and logo

signage

safety

competition

leisure

facilities

Signage

Ski trails

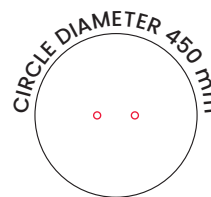

All signs feature 2 horizontal holes in the center for a clamp, except adhesive signs.

Signs available in different materials

- ABSXXX** polycarbonate
- ALUXXX** aluminum
- ADHXXX** adhesive

Ski trail signs



The following can be customized for these ski trail signs:

- Trail number
- Trail name
- Resort name
- With or without a logo
- With or without an edging around the sign



- ABS177**
- ALU239**
- ADH177**



- ABS176**
- ALU238**
- ADH106**



- ABS107**
- ALU107**
- ADH107**



- ABS178**
- ALU240**
- ADH178**





Ski trail prohibitive signs

Ø 450



No pedestrians

- ABS111
- ALU111
- ADH111



No alpine skiing

- ABS112
- ALU112
- ADH112



No sledding

- ABS114
- ALU114
- ADH114



No pedestrians / snowshoeing

- ABS115
- ALU115
- ADH115



No skiers

- ABS116
- ALU116
- ADH116



No swimming

- 250609
- 250611
- 250610



No ski touring

- ABS616
- ALU616
- ADH616



No flammable materials

- ABS192
- ALU274
- ADH192



No smoking

- ABS190
- ALU272
- ADH190



Do not leave skis here

- ABS191
- ALU273
- ADH191



No snowshoeing

- ABS216
- ALU240
- ADH178



Closed (in 4 languages)

- ABS185
- ALU267
- ADH185



No entry

- ABS108
- ALU108
- ADH108



No cross-country skiing

- ABS212
- ALU912
- ADH212



No littering

- ABS214
- ADH214



No pets

- ABS220
- ADH220



No snowmobiles

- ABS221
- ADH221



No skate skiing

- ABS215
- ADH215



No parking

- ABS109
- ALU109
- ADH109

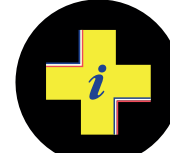

Rescue sign

- ABS113
- ALU113
- ADH113

Other visuals are available on request



signage

safety

competition

leisure

facilities

Ski trail triangular warning signs

500 x 500

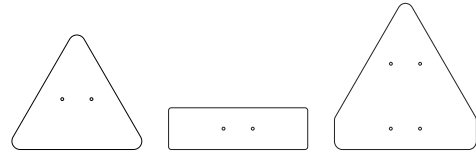

Different combinations available

Signs available in different materials



ABP
triangle + incorporated
tab sign
500 x 500 mm



triangle only
410 x 470 mm



DANGER

tab sign
150 x 500mm



- ABSXXX polycarbonate
- ALUXXX aluminum
- ADHXXX adhesive
- ABPXXX polycarbonate

<i>Danger</i>	<i>Beware skiers</i>	<i>Danger - cliff edge</i>	<i>Stream or lake</i>	<i>Sharp bend on the right</i>	<i>Sharp bend on the left</i>
▲ ABP118	▲ ABP122	▲ ABP189	▲ ABP186	▲ ABP187	▲ ABP188
▲ ABS118	▲ ABS122	▲ ABS134	▲ ABS267	▲ ABS268	▲ ABS269
▲ ALU118	▲ ALU122	▲ ALU134	▲ ALU334	▲ ALU335	▲ ALU336
— ABS126	— ABS130	— ABS139	— ABS337	— ABS338	— ABS339
— ALU126	— ALU130	— ALU139	— ALU341	— ALU342	— ALU343
<i>Thin snow cover</i>	<i>Snow cannon</i>	<i>Danger - Avalanche</i>	<i>Two-way traffic</i>	<i>Helicopter DZ</i>	
▲ ABP119	▲ ABP123	▲ ABP136	▲ ABP180	▲ ABP330	
▲ ABS118	▲ ABS123	▲ ABS136	▲ ABS264	▲ ABS330	
▲ ALU118	▲ ALU123	▲ ALU136	▲ ALU338	▲ ALU330	
— ABS127	— ABS131	— ABS141	— ABS341	— ABS336	
— ALU127	— ALU131	— ALU141	— ALU345	— ALU331	

Ski trail signage



Crossing	Beware pedestrians	Road crossing	Steep slope	Falling rocks
▲ ABP120	ABP124	ABP179	ABP181	ABP126
ABS120	ABS124	ABS263	ABS265	ABS270
▲ ALU120	ALU124	ALU337	ALU339	ALU110
ABS128	ABS132	ABS340	ABS342	ABS271
— ALU128	ALU132	ALU344	ALU346	ALU500

Surface lift crossing	Snow grooming	Crevasses	Lake	Snow grooming	Alpine skiing trail
▲ ABP121	ABP125	ABP135	ABP137	ABP176	ABP138
ABS121	ABS125	ABS135	ABS118	ABS118	ABS118
▲ ALU121	ALU125	ALU135	ALU118	ALU118	ALU118
ABS129	ABS133	ABS140	ABS142	ABS133	ABS143
— ALU129	ALU133	ALU140	ALU142	ALU133	ALU143

Snowmobile crossing	Winch cat grooming	Winch cat grooming	Backcountry skiing	Caution - beginners Learning area

Other visuals are available on request

Protecting birdlife in ski areas



photo credits: PNV

MBS IN PARTNERSHIP WITH THE BLACK GROUSE OBSERVATORY (OGM)



At a time when ski resorts are developing and expanding their winter activities, areas where wildlife can shelter during the winter are shrinking.

In addition to the challenges posed by climate change and habitat fragmentation, other issues are exacerbating the situation, such as the disturbance cause by human presence. Winter is a critical time of year for wildlife. Black grouse are a prime example. When the cold season sets in, they switch over to their very own energy saver mode by keeping any movements to a minimum and spending most of the time in their igloo, only coming out in the morning and at night to feed. Their habitat often tends to overlap those areas where ski resorts offer recreational activities.

In an effort to maintain human activities without endangering wildlife, quiet areas can be set up. Consultation with social and economic stakeholders from the local area is essential for garnering their support and ensuring that these quiet areas remain undisturbed.

FIND OUT MORE:
DOWNLOAD THE REPORT "BIRDLIFE AND SKI AREAS: SHARING THE SPACE":
votreparc.vanoise.com/6855-avifaune-et-domaines-skiables.html

CONTACT OGM:
OGM.VDS@GMAIL.COM



FEEDBACK FROM VAL CENIS

After consulting with the different stakeholders, two wildlife quiet areas were created in the Val Cenis ski area in 2020. These areas were marked out with green polycarbonate poles supporting four rows of bungee cords, to which soft flags and warning signs were attached. These measures proved to be ideal, since the birds were left undisturbed.

"All the stakeholders involved have accepted and incorporated the zones that we've identified as quiet areas. These areas are now an integral part of life in the ski area. We ensure that customers and employees are aware of their presence, so that they are left alone by as many people as possible."

**Yves Dimier (Ski Area Director)
and Jean-Christophe Gagnière
(Ski Trail Service Director)**

Ski trail signage

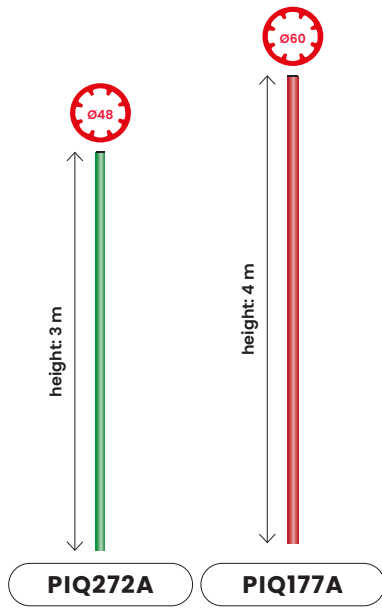

Fixing clip

- Ø 60 mm **ACC141**
- Ø 48 mm **ACC174**



- Ø 48mm **PIQ151**



Cable élastique (sur touret)

←→ 100mm - Ø8mm
ACC170



Anti-rotation support base for polycarbonate poles

- Ø 60 mm **PIQ189**
- Ø 48 mm **PIQ155**

According to the latest trials, the following method is the easiest way to set up and maintain a quiet area in a ski area:

- Fit polycarbonate poles into post support bases or natural supports. Attach three to four rows of bungee cords to the poles using fixing clips. This system is capable of adapting to different snow depths.

Poles: green and red poles are recommended

- Attach soft flags to the bungee cords using clamps.

Rope: yellow and black rope recommended

- "Quiet area" warning panels can be attached to some of the poles.

- Provide users with a way of bypassing the quiet area.

- Safeguard and protect the area by planting dense vegetation across the length of the uphill section.



photo credits: PNV

Self-colored yellow mesh flags (300 x 300 mm) with two eyelets



- COR233EN**
- COR233IT**

Polycarbonate panel (600 x 400 mm) without predrilled holes



- ABS256**
- ABS254**

Polycarbonate black grouse triangle (500 x 500 mm) with predrilled holes



- ABS262**



signage

safety

competition

leisure

facilities

signage

Information signs & special signs

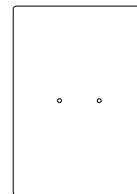

Signs available in different materials

- ABSXXX polycarbonate
- DIBXXX Dibond
- ALUXXX aluminum
- ADHXXX adhesive

350 x 500



Sledding area

- ABS237
- ADH389



Rescue station

- ABS247

Other visuals / references in 350 x 500 are available on request.

Other special signs



Swivel tab sign: open/closed

- ALU296

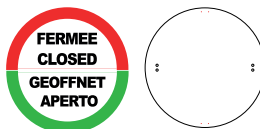

Swivel sign: open/closed

- ALU282



Sign - danger beyond this point

- PAPSRC204



No access to the ski area

- ALU299
- ADH299
- DIB299



signage

Sign - Hazards beyond waymarked trails

ALU265

safety

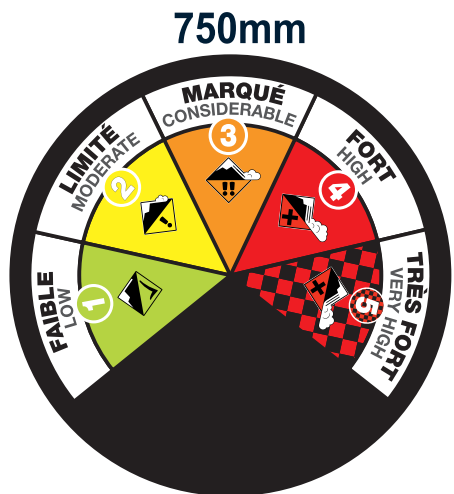

Avalanche risk sign made from composite aluminum (without an LED light). Sign mounted with a wheel featuring 5 risk levels represented by a pictogram and color.

ALU501

Identical to ALU501, but includes a removable, rechargeable LED light (manually operated) that replaces the "!" character at the top of the sign.

ALU501LED

competition

leisure

facilities

Flags - 1 m x 1.5 m



5/5 avalanche risk flag

253136



4/5 avalanche risk flag

253138



3/5 avalanche risk flag

253139



2/5 avalanche risk flag

253896



1/5 avalanche risk flag

253140



Rescue station flag

DIV111N

signage



Signage

Polycarbonate snowshoeing signs (without predrilled holes) complying with the corresponding AFNOR standard.



signage ←

Snowshoeing signage

Snowshoeing Keep left 14 x 14 cm	Snowshoeing Keep right 14 x 14 cm	No snowshoeing 14 x 14 cm	Snowshoeing – Single file on the left 14 x 14 cm	Snowshoeing – Single file on the right 14 x 14 cm
250596	250597	250599	250600	250601

safety

Customizable snowshoe trail 14 x 14 cm	Snowshoe trail 14 x 18 cm	Snowshoe trail 10 x 40 cm
250595	250594	250598

Send us the names, colors, number and arrow direction

competition

Sledding signage

To create your custom signs, see page 48-49

Customizable polycarbonate sledding area sign, 400 x 600 mm

ABS301

leisure

facilities

signage

Signage

Snow parks

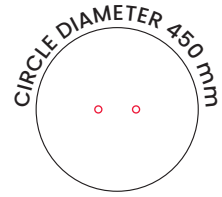

Signs available in different materials

ABSXXX

polycarbonate

ADHXXX

adhesive

ALUXXX

aluminum

Signs

difficulty levels Ø 450



ABS589

ADH589



ABS590

ADH590



ABS591

ADH591



ABS592

ADH592



ABS593

ADH593



ABS594

ADH594



Welcome sign
1500 x 1000 mm

ALU285

ADH285

Send us the name of the snow park and the mountain rescue no.



Proofing explanations and details on page 10



Snow park banners

Digitally printed PVC openwork mesh banner (W 1.00 m - H 0.60 m)
 Front: Trail difficulty / Back: No entry.

	FRONT	BACK	FRONT	BACK	
252208					252211
252792					252795
252209					252212
252793					252796
252210					254328
252794					254329

New snow park banners

High-visibility self-colored orange PVC openwork mesh banner (W 2.00 m - H 0.50 m)



BAN174	BAN175
BAN180	BAN181
BAN176	BAN177
BAN182	BAN183
BAN178	BAN179
BAN184	BAN185

Réf : Not mounted on fiberglass poles

Réf : Mounted on 2 fiberglass poles (1.50 m)

signage

safety

competition

leisure

facilities

Signage

ski lifts

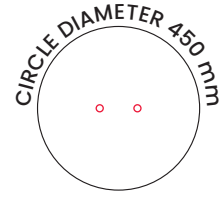

Signs available in different materials

- ABSXXX** polycarbonate
- ALUXXX** aluminum
- ADHXXX** adhesive

Prohibitive signs

Ø 450

 No entry ABS108 ALU108 ADH108	 No parking ABS109 ALU109 ADH109	 Closed (in 4 languages) ABS185 ALU267 ADH185	 No snowmobiles ABS221 ADH221	 No flammable materials D1-6 ABS192 ALU274 ADH192	 Do not exit the lift A1-1 ABS153 ALU153 ADH153
 No slaloming B1-1 ABS154 ALU154 ADH154	 Do not swing the chair A1-2 ABS155 ALU155 ADH155	 Do not let go of the bar B1-2 ABS156 ALU156 ADH156	 Backpacks always in front A1-3 ABS186 ALU268 ADH186	 Do not swing the gondola D1-1 ABS187 ALU269 ADH187	 Do not lean outside D1-2 ABS188 ALU270 ADH188
 No littering D1-3 ABS189 ALU271 ADH189	 No smoking D1-4 ABS190 ALU272 ADH190	 Do not leave skis here D1-5 ABS191 ALU273 ADH191	 No sitting or lying down ABS287 ALU287 ADH287		

 Do not lift the restraining device	 10t	 No lying down	 No sitting	 No entry	 INTERDIT AU PUBLIC	 Special equipment recommended	
							 Stop

Ski lift signage



Adhesive

Ø 100



Summary with 6 logos for gondola lifts 130 x 200 mm

ADH01



Falling hazard - opening doors 100 x 100 mm

ADH204_100



No pressing

ADH02



No standing

ADH03



No smoking

ADH04



Do not leave skis here

ADH05



No flammable materials

ADH06



Do not swing the gondola

ADH07



No leaning outside

ADH08



No littering

ADH09



Do not swing the chair

ADH10

Mandatory instruction signs

Ø 450



Lift ski tips

ABS157

ALU157

ADH157



Lower the restraining device

ABS158

ALU158

ADH158



Raise the restraining device

ABS159

ALU159

ADH159



Sit here

ABS160

ALU160

ADH160



Stand up and leave

ABS161

ALU161

ADH161



Unload and leave to the left

ABS162

ALU162

ADH162



Unload and leave to the right

ABS163

ALU163

ADH163



Unload and leave to the left or right

ABS164

ALU164

ADH164



Hold poles in one hand

ABS165

ALU165

ADH165



Leave the trail L/R

ABS166

ALU166

ADH166



Children under 1.25 m must be accompanied

ABS288

ALU288

ADH288



Arrival in ...

ABS300

ALU300

ADH300



Rescue sign

ABS113

ALU113

ADH113



Arrow in both directions

ABS169

ALU169

-

Rectangular signs

600 x 400



Approach one at a time

ABS147

ALU147

ADH147



Approach in groups of 2

ABS148

ALU148

ADH148



Approach in groups of 3

ABS149

ALU149

ADH149



Approach in groups of 4

ABS150

ALU150

ADH150



Approach in groups of 6

ABS152

ALU152

ADH152



Approach in groups of 8

ABS289

ALU281

ADH281



Arrival in ... m from the chairlift

ABS151

ALU151

ADH151



Loading carpet

ABS290

ALU276

ADH290



Sit in the middle of the seat

ABS291

ALU277

ADH291



Emergency stop button

ABS292

ALU278

ADH292



End of loading zone

ABS331

ALU332

ADH331



End of unloading zone

ABS332

ALU333

ADH332

signage

safety

competition

leisure

facilities

signage

Ski lift triangular warning signs

500 x 500

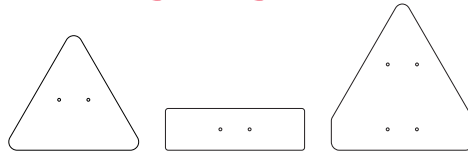

Different combinations available

Signs available in different materials



Triangle + incorporated tab sign
500 x 500 mm



Triangle only
410 x 470 mm



Tab sign
150 x 500mm

ABSXXX polycarbonate

ABPXXX polycarbonate

ALUXXX aluminum

ADHXXX adhesive

B 3-5	B 3-4	B 3-2	B 3-1	B 3-3
TELESKI DIFFICILE <i>Difficult surface lift</i>	PENTE 50% <i>Slope over 50%</i>	VIRAGE A DROITE <i>Right bend ahead</i>	VIRAGE A GAUCHE <i>Left bend ahead</i>	Skier crossing <i>Skier crossing</i>
▲ ABP174	▲ ABP176	▲ ABS170	▲ ABS171	▲ ABS172
▲ ABS174	▲ ABS173	▲ ALU170	▲ ALU171	▲ ALU172
▲ ALU174	▲ ALU173	▲ ABS175	▲ ABS202	▲ ABS172
▲ ABS175	▲ ABS202	▲ ALU175	▲ ALU279	▲ ALU172
▲ ALU175	▲ ALU279			

				D 3-1
ATTENTION SKIEURS BEWARE SKIERS <i>Beware skiers</i>	DANGER <i>Danger</i>	FAIBLE ENNEIGEMENT <i>Thin snow cover</i>	CROISEMENT <i>Crossing</i>	Fall hazard <i>Fall hazard</i>
▲ ABP122	▲ ABP118	▲ ABP119	▲ ABP120	▲ -
▲ ABS265	▲ ABS118	▲ ABS118	▲ ABS120	▲ ABS204
▲ ALU265	▲ ALU118	▲ ALU118	▲ ALU120	▲ ALU204
▲ ABS130	▲ ABS126	▲ ABS127	▲ ABS128	▲ -
▲ ALU130	▲ ALU126	▲ ALU127	▲ ALU128	▲ -

Other visuals are available on request



Danger - Surface lift



DANGER RALENTIR
Danger - Slow down



ATTENTION SKIEURS
Skier crossing



Information signs & special signs

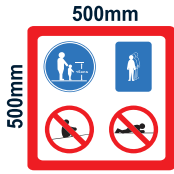

Information sign for conveyor belt

- ABS294**
-
- ADH294**

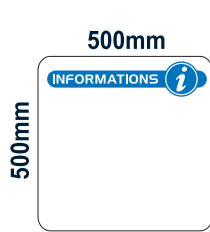

Information whiteboard 500 x 500

ABS334

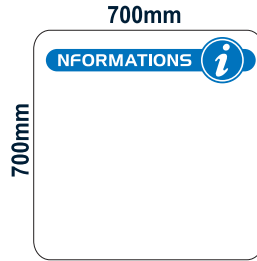

Information whiteboard 700 x 700

ABS335

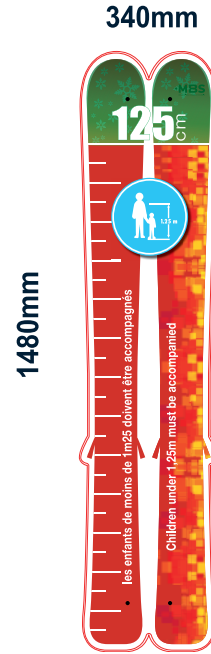

No entry under 1.25 m Composite aluminum sign

SIG512



signage

Fun runs and ski schools



Signs available in different materials

ABSXXX polycarbonate

ALUXXX aluminum

Ø 450 mm customizable signs

Tube-mounted

ABS183IN	Polycarbonate Ø 450 mm
ABS623IN	Polycarbonate Ø 650 mm
ALU245IN	Aluminum Ø 450 mm



Proofing explanations and details on page 10

Cable-mounted

ALU259	Dibond Ø 450 mm
ALU253	Dibond Ø 650 mm



Remember to send us your artwork



Find all our ski school and fun run products on page 186



Signage

Swiss ski areas

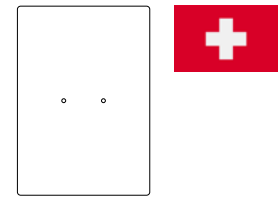

Signs available in different materials

ABSXXX polycarbonate

DIBXXX Dibond

Rectangular signs

400 x 600

DIB001 ABS512	DIB002 ABS513	DIB003 ABS514	DIB004 ABS515	DIB005 ABS516	DIB006 ABS517	DIB007 ABS518
DIB008 ABS519	DIB009 ABS520	DIB010 ABS521	DIB011 ABS522	DIB012 ABS523	DIB013 ABS524	DIB014 ABS525
DIB015 ABS526	DIB016 ABS527	DIB017 ABS528	DIB018 ABS529	DIB019 ABS530	DIB020 ABS531	DIB021 ABS532
					Endstation Terminus Termine Terminal 50 m	
DIB022 ABS533	DIB023 ABS534	DIB024 ABS535	DIB025 ABS536	DIB026 ABS537	DIB027 ABS538	

signage

safety

competition

leisure

facilities

signage

Signage

Swiss ski areas

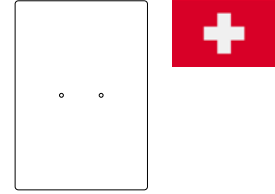

Signs available in different materials

ABSXXX polycarbonate

DIBXXX Dibond

Rectangular signs

400 x 600



DIB028

ABS539

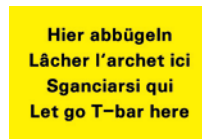

DIB029

ABS540



DIB030

ABS541



DIB031

ABS542



DIB056

ABS567



-

-

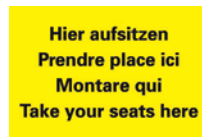

DIB033

ABS544



DIB034

ABS545



DIB035

ABS543



DIB057

ABS568

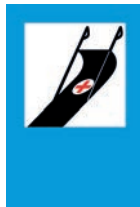

DIB051

ABS562



DIB052

ABS563

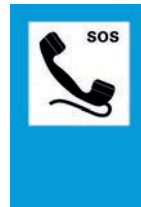

DIB053

ABS564

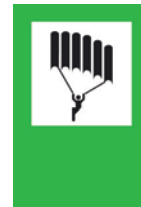

DIB054

ABS565



DIB055

ABS566





Rectangular signs

500 x 700



DIB047	DIB048	DIB049	DIB050	DIB058	DIB059	DIB060
ABS558	ABS559	ABS560	ABS561	ABS569	ABS570	ABS571



DIB061	DIB062	DIB063	DIB064	DIB065	DIB066	DIB067
ABS572	ABS573	ABS574	ABS575	ABS576	ABS577	ABS578



DIB068	DIB069	DIB070	DIB071
ABS579	ABS580	ABS581	ABS5822

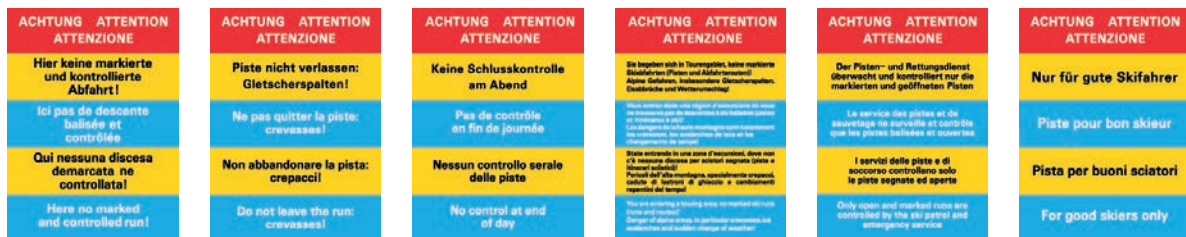

DIB035	DIB036	DIB037	DIB038	DIB039	DIB040
ABS546	ABS547	ABS548	ABS549	ABS550	ABS551



DIB041	DIB042	DIB043	DIB044	DIB045	DIB046
ABS552	ABS553	ABS554	ABS555	ABS556	ABS557

signage

safety

competition

leisure

facilities

Custom signs



Need a custom sign or cover? Our workshops and experts can fulfil your every need.



Aluminum sign with custom tab



Sign hinges and specific cut-outs



HD photo on expanded PVC



HD photo on transparent PC



Decorative sign made from printed wood



Various custom signs



3D printed wood assembly



What options are available?

01. Choose the material	Material comments	02. Dimensions	Choose the shape	Lamination possible?	
Composite aluminum (Aludibond® or Alupanel®) (thickness: 3 mm)	Durable	1.5 x 3 m (single panel)	Several shapes are available! - Triangle - Circle - Rectangle - Square - Arrows - and much more	Yes, these materials can be laminated Why laminate? Protect the visual against rain, splashes, UV rays, etc. Extend the lifespan. Ensure a higher quality finish.	
White or transparent polycarbonate (thickness: 3 mm)	Cost-effective, quick and unbreakable!	1.5 x 2 m (single panel)			
Digital sticker	Standard sticker	Strip width no more than 1.60 m			
Hightack sticker	Reinforced adhesive for bonding to galvanized steel	Strip width no more than 1.37 m			
Self-colored sticker	Ideal for low-slip covers	Strip width no more than 0.75 m			
3-ply larch (thicknesses: 19 and 26 mm)	Decoration Important: the grain may still be visible through the printed surface	Strip width no more than 0.75 m			NO
Expanded PVC (Komacel® or Forex®)	Decoration Important: breakable material	1.50 x 3.05 m (single panel)			NO
Akilux (polypropylene honeycomb)	Ideal for events	0.80 x 1.2 m (single panel)			NO
Aluminum (with sticker)	Hard-wearing	On request	On request	Yes, on the sticker	
Self-colored or digitally printed PVC canvas	Ideal for replacing openwork mesh (in areas with limited wind exposure)	On request	On request	NO	



Proofing explanations and details on page 10

EXTRA BENEFITS WITH MBS:

- Our latest-generation HP Latex R1000 printer, and our water-based eco-friendly inks
- Predrilled holes on request
- Several panels can be assembled together to create extra-large signage
- Assembly with the accessories recommended by our experts (clamps, poles, hinges, support bases, etc.)

Specific needs? You can count on our support with your projects.

Discover **our printing workshop**

Follow the printing process for our Mountain Planet
2024 goodies (our MBS smartphone stands).





01.



02.



03.



05.



04.



06.



07.



08.



01. Polycarbonate sheets inserted into the printer 02. Printer settings configured 03. Sheets printed 04. Sheets printed (continued) 05. Cutting machine programmed 06. Sheets cut out 07. Stands assembled 08. Eco-friendly water-based ink used in our latest-generation HP Latex R1000 printer

signage

safety

competition

leisure

facilities

Customizable banner flags



See-through 115 gsm mesh canvas, reinforced polyamide sleeve with a telescopic pole

Feather flags



Giant

5000 x 1000 mm flag



Medium

3500 x 750 mm flag



Mini

2220 x 600 mm flag

OPTIONS

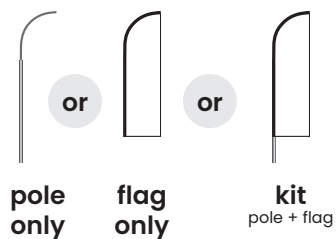

	Giant	Medium	Mini
Kit pole + flag	DPPL00001K	DPPL00002K	DPPL00003K
pole	DPAM00017	DPAM00018	DPAM00019
flag	DPPL00001	DPPL00002	DPPL00003

Accessories



Pied vis
Mini/ Médium

DPAM00001



Pied vis
Giant

DPAM00005

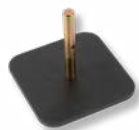

Pied
6 kg Mini

DPAM00002

12 kg Giant

DPAM00003

18 kg Giant

DPAM00014



Pied
Autocal

DPAM00015



Pied
Parasol

DPAM00020

Customizable banner flags



Rectangle flags



4 m swivel pole, and polycarbonate banner arm with double-sided printed PVC canvas

Dimensions: 2m x 0.5 m

Kit pole + flag	DIV607_611K
pole	DIV611
flag	DIV607



signage

safety



Proofing explanations and details on page 10

ID	Proofing type	Customer approval	Level of customization	Price
	Proofing without a signature	None	+	+
Z0103	Proofing service*	Up to two adaptations before the final proof	++	++
Z0104	Graphic design service*	Up to two adaptations before the final proof	+++	+++++
Z0175	Logo vectorization*	None	None	+

*Note: the order will be sent to production after the signed final proof has been received

competition

leisure

facilities

Signage

Totems, Panels and Arches

Get in touch to design your custom totem sign.

Large totem

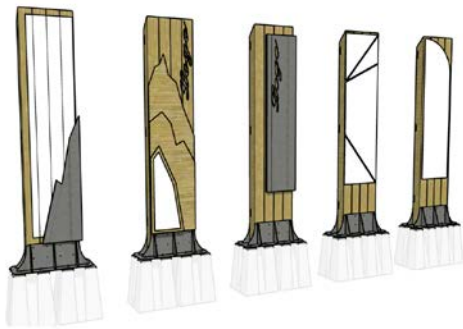

- Steel and wood structure
- Dimensions: H 4 m
- Custom shapes and colors
- ANCHORED TO A CONCRETE SLAB
- Printing on Dibond
- Treatment for the raw wood surface (option: oil or paint)
- Treatment of the steel surface (paint color to be defined; rust option)

High wind resistance	✓
Long lifespan	✓
Safety (absorbs impacts)	✗
Eco-friendly materials	✓
Standard outdoor furniture	✗
Custom outdoor furniture	✓

Bollard



- Steel and wood structure
- Dimensions: H 1.50 m or 2.70 m
- Custom shapes and colors
- Anchored to a concrete slab
- Printing on Dibond
- Treatment for the raw wood surface (option: oil or paint)
- Treatment of the steel surface (paint color to be defined; rust option)

High wind resistance	✓
Long lifespan	✓
Safety (absorbs impacts)	✗
Eco-friendly materials	✓
Standard outdoor furniture	✗
Custom outdoor furniture	✓

Panel



- Steel and wood structure
- Dimensions: H 3 m / 3 m
- Custom shapes and colors
- Anchored to a concrete slab
- Printing on Dibond
- Treatment for the raw wood surface (option: oil or paint)
- Treatment of the steel surface (paint color to be defined; rust option)

High wind resistance	✓
Long lifespan	✓
Safety (absorbs impacts)	✗
Eco-friendly materials	✓
Standard outdoor furniture	✗
Custom outdoor furniture	✓



Arch



- Steel and wood structure
- Dimensions: H 3.5 m / 4 m
- Custom shapes and colors
- Anchored to a concrete slab
- Treatment for the raw wood surface (option: oil or paint)
- Treatment of the steel surface (paint color to be defined; rust option)

High wind resistance	✓
Long lifespan	✓
Safety (absorbs impacts)	✗
Eco-friendly materials	✓
Standard outdoor furniture	✗
Custom outdoor furniture	✓

Foam totem

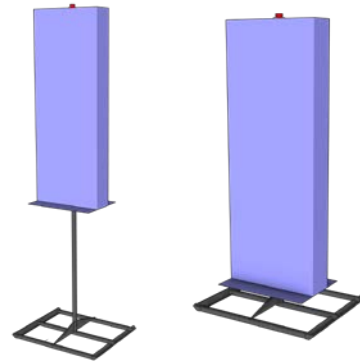

- Steel and PC structure for greater safety
- Water-repellent foam to prevent ice from forming inside the structure
- Cover printed on both sides
- Dimensions: H 2.4 m / 0.90 m
- Custom shapes and printed finishes
- Base: steel sled base to be buried beneath the snow

EXTRA BENEFITS: This foam totem can be used to install a small totem sign in areas where space is at a premium. The chassis base is buried beneath the snow for added stability. The chassis features a height-adjustable design.

Easy to transport	✗
High wind resistance	✗
Long lifespan	✗
Easy to store	✗
Safety (absorbs impacts)	✓
Eco-friendly materials	✓
Standard outdoor furniture	✗
Custom outdoor furniture	✓

Large foam totem

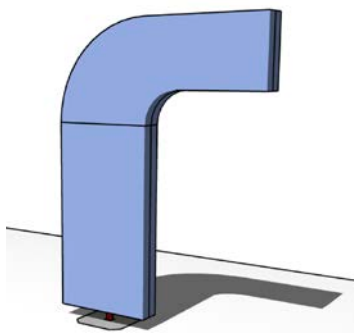

- PC structure for greater safety
- Water-repellent foam to prevent ice from forming inside the structure
- Cover printed on both sides
- Dimensions: H 3 m / 2 m
- Custom shapes and printed finishes
- Choice of bases: base with mounting plate

Easy to transport	✓	Safety (absorbs impacts)	✓
High wind resistance	✗	Eco-friendly materials	✗
Long lifespan	✓	Standard outdoor furniture	✗
Easy to store	✗	Custom outdoor furniture	✓

Signs

Avalanche Risk



Avalanche Risk Signs

LMP101

Low-Tech Avalanche Risk Sign with indicators



No double data entry thanks to interoperability with various market systems: LumiPlay, ATEN, DigiSnow.



► Complies with AFNOR AC S52-092 standard (mandatory information)

- ✓ Display of the 5 risk levels in French and English
- ✓ Real-time risk indication via LED
- ✓ LED flashing: from risk level 3 or 4
- ✓ Access to the Météo-France avalanche bulletin (BRA) via QR code

► Technical specifications

- Printed Dibond panel, UV-treated, resistant to radiation and damage (graffiti)
- 1 high-brightness flashing light, Ø 80 mm (outer diameter) + 5 risk indicator lights
- High-brightness avalanche indicators, Ø 25 mm (amber) and power supply unit and control electronics housing
- Metal frame casing: yellow color, satin lacquer finish: W80 × H120 × D12 cm
- Wall or pole mounting

► Technical requirements

- Power supply + communication network

Full LED Avalanche Risk Sign

LMP102

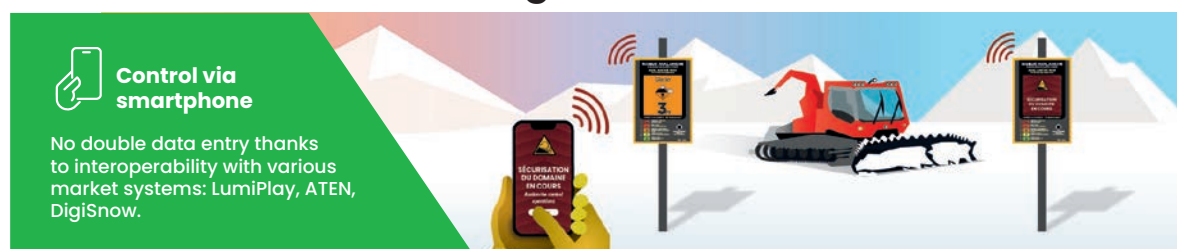

No double data entry thanks to interoperability with various market systems: LumiPlay, ATEN, DigiSnow.



► Preconfigured content controllable via smartphone

- ✓ Avalanche Risk
- ✓ Avalanche Control (PIDA)
- ✓ Damage Alert
- ✓ Winch Alert
- ✓ Area Closed
- ✓ Emergency Number
- ✓ Time + Date + Temperature

► Technical specifications

- High-brightness LED display
- Power supply unit and control electronics housing
- Metal frame casing: yellow color, satin lacquer finish: W80 × H120 × D12 cm
- Wall or pole mounting

► Technical requirements

- Power supply + communication network



LED Screens

Slalom Stadium



► Technical specifications

Mounting: wall-mounted or single-post

LMP202 Size: 2 m × 1 m / 2 m²

LMP203 Size: 2.5 m × 1.5 m / 3.75 m²

LMP206 Size: 3 m × 2 m / 6 m²

Other sizes available on request

Adapted to all environments

11	5	DEFAUX XAVIER	02:09	🏆
12	11	OLU-MONTY ELISE	02:14	🏆
13	8	PAUPRE VINCENT	02:20	🏆
14	7	ELIE ALDOREY	02:26	🏆
15	9	BOSLAIRE GASPARD	02:35	🏆
16	9	CHAMVIN EDGAR	02:46	🏆
17	8	MILAN CLEMENT	02:51	🏆
18	8	CANAVERE BIANCA	02:52	🏆
19	2	HURE PHILIPPA	03:03	🏆
20	6	DEFAUX RAPHAEL	1:38:35	🏆

Timing
Display finish times and race rankings.



Live Input
For events, the screen can be used as a mirrored display.



Timing & Video Replay
Overlay times and results on a slow-motion video of the skier's final gates.

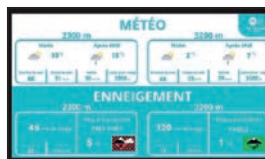

Ski Area Information
Broadcast real-time information about the ski area (pre-programmed content loops: images, videos, weather, lift status, etc.).



Automated system with 2 modes:
• Race
• Non-race (recreational skiing)

Panels for LED Screens

Contact us to design your custom panel:

- Steel and wood structure
- Dimensions: H 3 m / W 2 to 3 m
- Customizable shape and color
- Mounted on a concrete base
- Dibond printing
- Wood surface treatment: raw finish, oil or paint options
- Steel surface treatment: RAL paint (to be defined), rust finish option

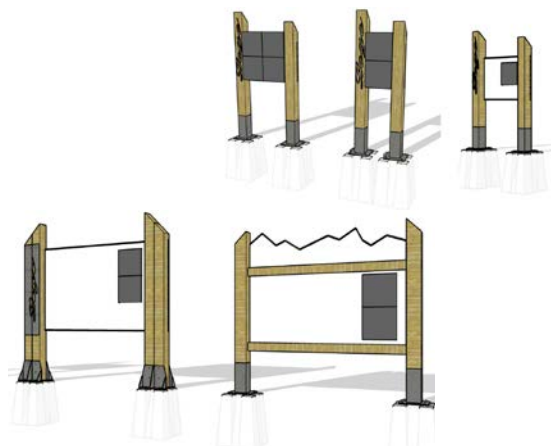

signage

safety

competition

leisure

facilities

Safety

◆ MBS: BEST-FIT SOLUTIONS FOR YOUR EVERY NEED



Rescue toboggans and sleds	P. 60
Immobilization equipment	P. 66
Emergency medical equipment	P. 68
Avalanche safety and rescue equipment	P. 74
Personal equipment for ski patrollers	P. 76
Rescue team equipment	P. 78
Customize your pads	P. 82
Standard crash pads	P. 86
Discover our crash pad workshop	P. 92
Poles and stakes	P. 94
Protection equipment	P. 102
Protective netting and poles	P. 104
Modulo	P. 112
Netting	P. 114
Accessories for banners, poles & fencing	P. 120



safety

Rescue toboggans and sleds



The MBS rescue toboggan

lightweight and easy to handle

- 1 Chassis: AGS aluminum
- 2 Runners: HDPE
- 3 Brakes: ARDOX
- 4 Lifting handles: Stainless steel
- 5 Lift-up canopy
- 6 Patient straps



	Cover and canopy colors (without printing)	Dimensions	Weight	ID
MBS rescue toboggan		L x W x H 2.15 m x 0.70 (with lifting handles) x 0.70 m (canopy unfolded)	41 kg	TRX126D
MBS rescue toboggan		L x W x H 2.15 m x 0.70 (with lifting handles) x 0.70 m (canopy unfolded)	41 kg	TRX126D_RJ

Customize your MBS toboggans



TRX126DP



Proofing explanations and details on page 10

To customize the cover and canopy, simply include your logo or provide an illustration for a fully printed cover





Accessories and spare parts



Pads with built-in cushion

TRX109



Set of two covers



TRX113



TRX113RJ



Canopy with 2 transparent windows



TRX115



TRX115RJ



Red and yellow retrofit kit including 1 cover and 1 canopy

TRX1135K



Red and yellow retrofit kit including 1 cover and 1 customizable canopy

TRX1135PK



Patient straps (set of 4)

TRX117



Long strap (single)

TRX1170



Short strap (single)

TRX1171



Chassis strap attachment bracket

TRX172



Pull straps with D-rings

TRX116

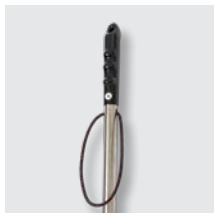

Lifting handle (usable on left or right side)

TRX139



Soft black grip for lifting handle

TRX136



Right brake

TRX140D

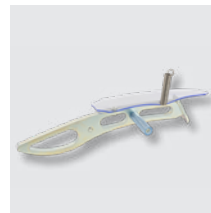

Left brake

TRX199G



Brake deflector

TRX133



Runner (usable on left or right side)

TRX134

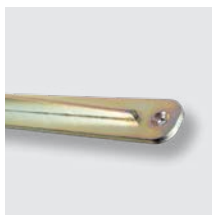

Predrilled runner fin

TRX158



Runner half-round

TRX163A



Brake spring

TRX176



Yellow chassis handle

TRX164

safety

GMS toboggan



Produced to order; contact us



Available for season hire



Exclusivité MBS



- Improved patient comfort with a seated (60% of incidents) or lying position, depending on the injury
- Can be loaded on a chairlift (even in V3) in alignment with the seat (chairlifts with 3 or more seats - ski lift approval required)
- Comfort for rescue teams: easy to handle, even on steep trails
- Constant view of the patient, and excellent sliding performance with the skis
- Fast response and patient transport
- Can be customized for ski area events, transporting equipment, or for use as a ski taxi

TRX222



Snowmobile sled with shock absorbers

OPTIONS



Sled only

or



kit sled + shell



Produced to order; contact us



Ski sled

Fitted with plastic runners for sliding through the snow; can be pulled by a quadbike or snowmobile.

TRX220

Fiberglass polyester shell

Foam mattress with a heat-welded wrap
 3-part cover
 Closed with straps, including straps for securing skis
 6 carrying handles - Folding canopy
 Quick fastening with 3 toggle clamps

TRX220 + TRX221

	Dimensions	Weight	ID
Ski sled	L x D x H 2.80 m x 1.10 m x 0.45 m	55 kg	TRX220
Shell	L x W 2 m x 0.7 m	15 kg	TRX221



Tipping cargo sled for transporting snow



Aluminum cargo sled for transporting equipment, with a drawbar, hitch pin and safety cable. Maximum load: 500 kg.



	Dimensions	Weight	ID
Tipping cargo sled for transporting snow	L x D x H 2 m x 0.80 m x 0.3 m	84 kg	TRX223K

Cargo sled for transporting equipment



Aluminum cargo sled for transporting equipment, with a drawbar, hitch pin and safety cable. Maximum load: 500 kg.



	Dimensions	Weight	ID
Cargo sled for transporting equipment	L x D x H 2.25 m x 0.80 m	66 kg	TRX224K

signage

safety

competition

leisure

facilities

safety

Rescue toboggans and sleds

MBS: official supplier for ©TYROMONT, Alpine rescue equipment



Alpine Rescue Equipment
TYROMONT

Canadier rescue sled

©TYROMONT

Aluminum Canadier rescue sled with chain brake (without mattress)

Dimensions	Weight	ID
2 m x 0.60 m	19 kg	TRX225

Mattress with built-in cushion

Dimensions	Weight	ID
2 m x 0.60 m	4 kg	TRX109



AKJA 2200 rescue sled

©TYROMONT

Sled only with 4 poles

Dimensions	Weight	ID
2.20 m x 0.56 m	24 kg	TRX148

Mattress for AKJA 2200

Sled mattress **TRX156**

Thermo rescue bag cover **TRX173**

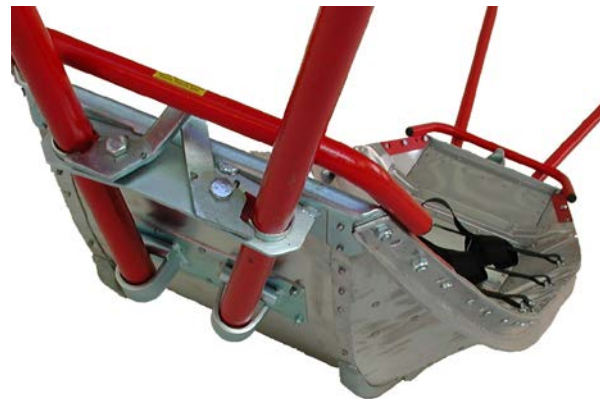

Accessories

for AKJA 2200 rescue sleds



Brake chain

TRX157



Replacement pole (single)

TRX198



Front/rear guide handle

255726



AKJA rescue sled drawbar

TRX202

©TYROMONT rescue toboggans and sleds



Rescue trailer

©TYROMONT

Rescue trailer for snowmobiles and quad-bikes

Trailer dimensions Overall dimensions	Weight	ID
1.90 m x 0.8 m 2.6 m x 0.8 m	23 kg	TRX178



signage

Accessories

for rescue trailers



Bacteriostatic cover
190 x 110 cm

SEC239



Bacteriostatic duvet
250 x 150 cm

SEC139



Single-use survival blanket

SEC198

TYROMONT
Contact us for the entire Tyromont range

safety

competition



leisure

facilities

Vacuum immobilization equipment

The products in our immobilization equipment range guarantee excellent hygiene conditions and easy cleaning with their smooth surfaces. The triple radio-frequency welded assemblies ensure a perfect seal and tear resistance. The self-extinguishing polystyrene beads enclosed in the splints and mattresses are expanded and calibrated to ensure long-term use without any compaction.

Mattress

Also known as a "vac mat", this mattress is designed to immobilize all or part of a trauma victim's body.

Full body mattress, 3 thicknesses (2 PU layers + 1 Cordura layer)

- ① Carrying handles
- ② Quick-release buckle straps
- ③ 1/4 turn metal valve
- ④ Micro-bead filling

SEC494

Children's partial body mattress, 3 thicknesses (2 PU layers + 1 Cordura layer), quick-release buckle straps, 1/4 turn metal valve, micro-bead filling

SEC493



Customize your immobilization mattresses



Full body mattress, 3 thicknesses
(2 PU layers + 1 Cordura layer), identical to SEC494 with the possibility of customization

SEC494P

Get in touch!



Proofing explanations and details on page 10

200 x 35 mm PVC canvas label sewn onto the retaining strap

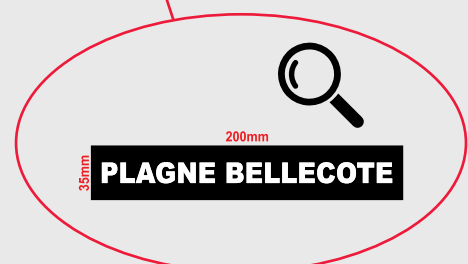
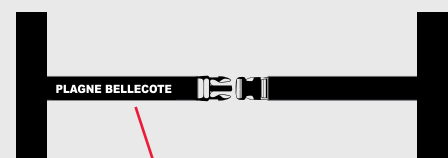



Accessories



Blue full body
mattress
carrying bag.
PVC-coated fabric.

TETPDP006

Vacuum splints



For forearms
54 x 36 cm
2 hook-and-loop
straps
PVC-coated PES fabric

SEC131



For arms 70 x 48 cm
4 hook-and-loop
straps
PVC-coated PES
fabric

SEC129



For children's legs
86 x 58 cm
5 hook-and-loop
straps
PVC-coated PES fabric

SEC305



For adult legs
107 x 87 cm
4 hook-and-loop
straps, 2 PU layers +
1 Cordura layer

SEC493

Double action vacuum pumps



Spencer aluminum
pump
QMX120

Weight:
1.3 kg

Dimensions
48.5 x Ø 6 cm

SEC148A



Spencer alumi-
num infusion pump
QMX130

Weight:
0.5 kg

Dimensions
32 x Ø 5.5 cm

SEC450



DMT aluminum
pump

Weight:
1.4 kg

Dimensions
48.5 x Ø 6 cm

SEC150



DMT6 PVC pump
(without a stirrup)

Weight:
1.17 kg

Dimensions
47 x Ø 11 cm
(not including hose and handle)

SEC145

Emergency medical equipment



Laerdal
helping save lives



Shoulder / elbow immobilizers

SEC168

SOBER shoulder / elbow immobilizer

SEC563

For wrists



"SMURFORM" splints

SEC140

For forearms

SEC136

For elbows / arms

Other items in the SMURFORM range are available on request, including adult & children's leg splints, bags and kits.

Extrication device

SEC307

SPLINT
Cervical thoracic



Spinal board



**NAJO LITE YELLOW
SPINAL BOARD**
Dimensions:
183 x 41 x 4.5 cm

SEC345



**"Universal"
HEAD IMMOBILIZER**

SEC451



**SPEEDBLOCKS HEAD
IMMOBILIZER**
For NAJO LITE
spinal board

SEC350



**Hook-and-loop SPI-
DER STRAP**
(allow 1 strap per
spinal board)

SEC380



Stretcher



Scoop stretcher
Ferno Scoop S-265,
EN 1865 compliant

251106



Radiolucent scoop
stretcher with
3 straps

SEC222

Neck brace "PATRIOT"

High-density PE
covered with closed cell foam



Single adult neck
brace (adjustable
to 4 positions)

SEC506



Single children's neck
brace (adjustable
to 3 positions)

SEC507

Neck brace "SOBER"

High-density PE covered with
closed cell foam



Sober neck brace
carrying bag

SEC308

Size	Color	ID
Adult - 1	●	SEC141
Adult - 2	●	SEC194
Adult - 3	●	SEC195
Children - 1	●	SEC142
Children - 2	●	SEC196
Children - 3	●	SEC197

Neck brace "NECKLITE"

252154

Modular neck brace, with a quick-fitting and lightweight design.

The brace molds to the patient's unique features with the tabs positioned beneath the chin. With its space-saving design, it can easily be stored in an emergency medical bag.



safety

Emergency medical equipment

Ambu

Laerdal
helping save lives

Diagnostic equipment



UB-511
digital wrist
blood pressure
monitor

SEC309



OxyWatch
fingertip
pulse
oximeter

SEC709

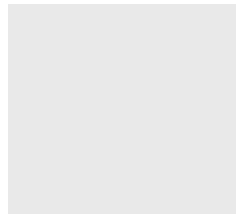

OxyWatch
case

SEC7091

**ITEM ON
CLEARANCE!**



UB-525 IHB auto-
matic wrist blood
pressure monitor

SEC223



Oxy-3
fingertip
pulse
oximeter

SEC224



Protective
case
for Oxy-3
oximeter

SEC225

Transparent masks for ambulances



Size	ID
5 - adults	SEC245
3-4 - teenagers	SEC161
2 - children	SEC244
1 - babies	SEC243

Emergency medical equipment



CRP RESCUE MASK
with hard case

SEC165



2.10 m OXYGEN TUBING with connectors at each end

SEC315



Single-use plastic cannulas
(set of 8 sizes)

SEC262



Antibacterial filter

255157



OXYGEN MASKS

Medium concentration	ID
Adult size	SEC311
Children's size	SEC312

used to enrich the inhaled air with an oxygen concentration of around 50%.

High concentration	ID
Adult size	SEC313
Children's size	SEC314

used to inhale oxygen concentrations close to 100%.



ADULT TOURNIQUET
Tactical
tourniquet
SOF TACTICAL

254002

Single-use resuscitators



Resuscitator	Size	ID
Adult + O2 reservoir bag + mask	5	SEC256
Child + O2 reservoir bag + mask	3	SEC257
Infant + O2 reservoir bag + mask	1	SEC258

Emergency medical equipment



Laerdal
helping save lives



Secretion aspirators and accessories



ASPIRATOR,
RECIPIENT AND
CATHETER
"Vac Breezer"
secretion aspirator
supplied with
single-use recipient
and catheter

SEC316



Single-use recipient
+ cap for Vac Breezer
aspirator

SEC317



Catheter
for Vac Breezer
aspirator

SEC318



Dumont aspirator
catheters with
double taper
connector (box of 25)

SEC408

Defibrillator Powerheart G5 CARDIAC SCIENCE

SEC822

Standard Powerheart G5 semi-automatic defibrillator.
First automated external defibrillator combining variable escalating energy for administering the appropriate therapy for the patient's condition, fast shock times and real-time CPR feedback.

Designed to help responders take fast and effective action.



Accessories



Semi-rigid transport
bag with a shoulder
strap and pockets.

SEC829



Intellisense battery,
5-year shelf life

SEC831

Electrode pads

SEC827

Adult electrode pads (pair)

SEC828

Pediatric electrode pads (pair)

With non-polarized electrodes, both pads can be placed in either position on the patient's chest (upper-right or lower-left).

Automatic synchronization between the pads and defibrillator.



Other items in the Powerheart G5 range are available on request



Therm'up



SEC125

HEATED VEST with built-in batteries

Powerful heating system with three temperature settings (39°C, 35°C and 30°C) on the control screen

- Can be used in all situations
- Lightweight (approx. 1 kg) and easy to transport
- Quick and easy to fit
- 4-hour battery life; batteries can be recharged and reused after simply disinfecting
- Robust, impermeable textile



signature

sécurité

Bags

Oxygen therapy

SAC389

DMT OXYGEN THERAPY BAG

Red Cordura,
5-liter cylinder.



251978

FIRST RESPONDER BACKPACK

35 liters - Compact and lightweight
5 removable pouches
1 removable ampoule bag
1 insulated pouch



compétition

leisure

aménagement

safety

Avalanche safety and rescue equipment



Mammut transceiver



BARRYVOX S2

SEC338



BARRYVOX

SEC495



We can also service and repair your Barryvox devices

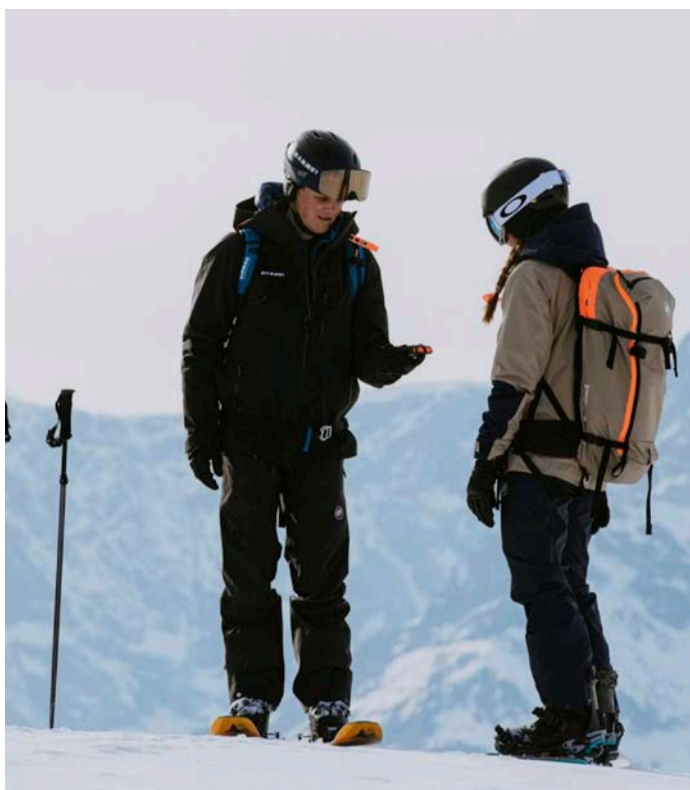



Individual probes



ORTOVOX "240 PFA"
aluminum probe
featuring a wrist strap and PFA
quick-assembly system - Ø 11
mm / L 2.40 m / Weight 240 g

SEC320



**ORTOVOX "PRO STEEL
320 PFA"** stainless
steel extendible probe
featuring a cable draw and PFA
quick-assembly system
Ø 12 mm / L 3.20 m /
Weight 560 g

SEC202



**ORTOVOX
"240 HD PFA"**
aluminum probe
featuring a cable draw and
PFA quick-assembly system
Ø 13 mm / L 2.40 m

SEC373



Carbon probe
H 4 m, lightweight and rigid,
non-folding, with Ø 14 mm
aluminum tip, single-piece shaft

SEC178



MSR STRIKER
aluminum probe
320 cm

257600



Avalanche shovels



PRO RESCUE SHOVEL

SEC874



PRO GUIDE SHOVEL

SEC875

signage

safety

competition

leisure

facilities

safety

PERSONAL equipment for ski patrollers

PETZL

CAMP

TSL
RESCUE
CAMP

PLASTIMO



**ORTOVOX
BACKPACK**
"Haute Route"
32 liters
Orange

SAC415Colors subject
to availability

**ORTOVOX
BACKPACK**
"Cross Rider" - Black
20 liters

SAC405

"Sirocco" HELMET
PETZL - Black
Size 1 - Ref. A073BA00

253994

Size 2 - Ref. A073BA01

253995

**RADIO
HOLSTER**

SAC410

FIRST AID ROLL DOC
ORTOVOX MODEL
with contents
15 x 10 x 6 cm

SAC566

**COMPACT
CRAMPONS**
PETZL
All-aluminum
construction.
Supplied with a bag.

253996

RIDE ICE AXE
PETZL
240 g

253998

**"CREVASSE"
RESCUE KIT**
PETZL - Black
Weight: 1 kg
1 Tibloc - 1 Micro Traxion
3 connectors
30 m rope
1 ST'Anneau sling

253999

Rescue signage 1 m x 0.30 m



SPECIAL RESCUE BANNER
Mounted on fiberglass poles
1 m x 0.30 m

BAN148



Avalanche safety and rescue accessories



TSL AVALANCHE MARKING SET

SAC139



- JAL156** ● RECTANGULAR FLAG 20 x 30 cm BLUE
- JAL157** ● RECTANGULAR FLAG 20 x 30 cm Y/B CHECKER
- JAL154** ● RECTANGULAR FLAG 20 x 30 cm ORANGE
- JAL155** ● RECTANGULAR FLAG 20 x 30 cm PURPLE
- JAL197** ● RECTANGULAR FLAG 20 x 30 cm RED
- JAL159** ● GREEN TRIANGULAR FLAG



FLOATING SMOKE FLARE
(smoke)

duration 3 min - orange

DIV129

HANDHELD DISTRESS FLARE
(flame)

duration 1 min - red

DIV130



SUSPENSION HARNESS

for rescue dogs
CAMP Kronos 2171 model

SEC501



MEGAPHONE

DIV186

Hillside dam rescue



LIFEBUOY CABINET

for such bodies of water as hillside dams and lakes, including 1 cabinet, 1 x Ø 70 lifebuoy and 1 x 30 m throwing line.

SEC266



SOLAS LIFEBUOY

Ø 75, 2,7 kg and 1 x 30 m throwing line.

SEC504

Rescue team equipment

Please contact us for all other references.

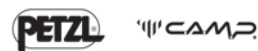

Rescue pulley

PETZL
Rollcab

SEC271



«OK» carabiner

PETZL
TRIACT-LOCK

SEC272



«AM'D» carabiner

PETZL
TRIACT-LOCK

SEC572



Aluminum «WILLIAM» carabiner

PETZL
Large opening
TRIACT-LOCK

SEC428



Aluminum «OK» carabiner

PETZL
SCREW-LOCK

SEC436



«VERTIGO» carabiner

PETZL
Twist-lock for
progression lanyard

SEC702



«PAW L» rigging plate

PETZL

SEC463



«PAW S» rigging plate

PETZL

252927



Anchoring sling

PETZL
«Connexion vario»

SEC273



Evacuation triangle

PETZL
Pitagor

SEC417



Evacuation triangle

PETZL
Angel
(adjustable in 4
sizes)

SEC502



Semi-static rope

PETZL
"Axis" Ø11mm
per meter
LENGTH 50m

SEC812

LENGTH 100m

SEC118

LENGTH 200m

SEC119



ROPE PARALLEL D10,5

PETZL
100m WHITE
LENGTH 50m

SEC280

LENGTH 100m

251239



Belay / descender device «IDS» Yellow

PETZL

SEC103



«CROLL» Chest ascender

PETZL

Ø8 to 13mm

SEC557

Harness
accessory



«OMNI» Half-round carabiner

PETZL
TRIACT-LOCK

SEC429

Rescue team equipment



DESCENDER
PETZL "RIG"

SEC426



TURBO CHEST
chest ascender
CAMP

250555



Handled ascender
PETZL
wide and ergonomic
overmolded handle

SEC558

right-handed

left-handed

SEC559



Mobile fall arrester for rope
PETZL "ASAP"

SEC296

Harnesses



Newton EASYFIT
PETZL
Fall-arrest harness
International
version
Size 0

251608

Size 1

251609

Size 2

251610



Newton
PETZL
Fall-arrest harness
European version
Size 1

252162

Size 2

252163



VOLT
PETZL
Fall arrester for work
at height
Size 0

252164

Size 1

252165

Size 2

252166



AVAO BOD FAST
PETZL
Fall arrester for work
at height
Size 0

SEC3660

Size 1

SEC366

Size 2

SEC3662



GOLDEN
Top Plus -
aluminum with
automatic buckles
CAMP
Size 1

SEC555

Size 2

SEC5552

Helmets

VERTEX helmet



WHITE

SEC683

Ventilated WHITE

SEC288



FLUORESCENT YELLOW

252739

Ventilated
FLUORESCENT YELLOW

252193

Ventilated YELLOW

SEC270



ORANGE

SEC677

SKYLOR Plus helmet



(BLACK, WHITE), RED

SEC497



YELLOW

252738

Headlamps



PIXA 1
Max range:
25 m

SEC465



PIXA 2
Max range:
30 m

SEC447



PIXA 3
Max range:
55 m

SEC496



PIXA 3R
Max range:
75 m

SEC521

signage

safety

competition

leisure

facilities

Rescue team equipment



Lanyards



Fixed lanyard
with sewn terminations

Size	Weight	ID
60 cm	108 g	SEC107
100 cm	130 g	SEC108
150 cm	185 g	SEC109
200 cm	225 g	SEC110



Adjustable lanyards - GRILLON
L52 for work at height

Size	Weight	ID
200 cm	480 g	SEC111
300 cm	560 g	SEC112
500 cm	720 g	SEC113

Replacement rope for Grillon lanyards

Size	ID
200 cm	SEC420
300 cm	SEC421
500 cm	SEC422

Grillon replacement rope

200 cm with MGO connector **SEC865**

300 cm with MGO connector **SEC423**

Fall-arrest lanyards

European version



Absorbica "Y"
with energy absorber - European version
80 cm - Rope
(1.05 m with MGO connectors)

SEC424

International version



Absorbica "Y"
Double lanyard with integrated energy absorber
and MGO connectors, 80 cm

251658



Absorbica "Y"
150 cm - Conventional strap
(1.75 m with MGO connectors)
Double lanyard with integrated
energy absorber and MGO connectors

SEC425

Rescue team equipment



Compact, open-gated swivel

252226



"MGO OPEN" connector
PETZL Ø 60 mm
Ideal for Absorbica fall-arrest lanyards

251462



"EASHOOK OPEN" connector
PETZL

254047



"ABSORBICA" absorber
PETZL

SEC294



"SHOCK ABSORBER" energy absorber
CAMP

SEC295



"ICE MASTER" crampons
CAMP - 4 sizes

SEC500



"IRVIS" crampons
PETZL
10-point

SEC394



"GLACIER LITERIDE" ice axe
PETZL - L 50 cm

252102



"PRO TRAXION" pulley
PETZL

SEC514

Open loop slings - PETZL



60 cm

SEC516



80 cm

SEC517



120 cm

SEC518



150 cm

SEC519

Bags



BUCKET
yellow PETZL

SAC388



TRANSPORT
yellow PETZL

SEC281



MARINER
red
30 liters

SAC396



signage

safety

competition

leisure

facilities

Customize your pads

Let's work together in designing your custom safety pads.

We can also create a cover for any type of foam. Contact us to find out more.



◆ MBS: BEST-FIT SOLUTIONS FOR YOUR EVERY NEED



01.

Choose the cover color

02.

Choose your print type

03.

Choose your foam

04.

Choose your shape

05.





Choose your options

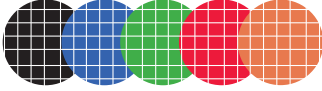

Customize your pads

01. Choose the cover color

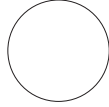
We can also offer a wide range of cover colors on request. You can use different colors for the front and back.

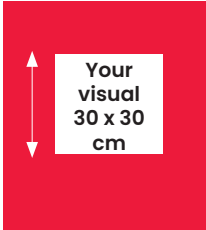
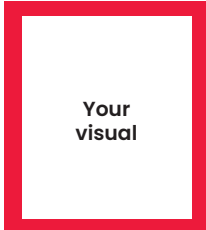
Self-colored covers		Digitally printed cover
 <p>SMOOTH PVC COVER 650 gsm Subject to stock availability</p>  <p>LOW-SLIP COVER 700 gsm Blue and black subject to stock availability Green, red and orange in stock</p>  <p>CUSTOM COVER On request (subject to a minimum order quantity) Gsm, color and smooth or low-slip texture Customizable</p>		 <p>DIGITALLY PRINTED COVER 510 gsm In stock</p>
Color fade resistance	✓	✗
Abrasion sensitivity	✓	✓
UV sensitivity	✗	✓ ✗
 <p>Non-customized pad</p>		 <p>Standard customized pad</p>
 <p>Total customized pad</p>		

02. Choose the print type

On self-colored covers, we can stick printed designs to smooth covers or heat-weld them to low-slip covers. Digital covers are printed entirely according to your artwork file.



Proofing explanations and details on page 10

ID	Proofing type	Customer approval	Level of customization	Price
	Proofing without a signature	None	+	+
Z0103	Proofing service*	Up to two adaptations before the final proof	++	++
Z0104	Graphic design service*	Up to two adaptations before the final proof	+++	+++++
Z0175	Logo vectorization*	None	None	+

*Note: the order will be sent to production after the signed final proof has been received

signage

safety

competition

leisure

facilities

03. Choose the foam

We work with two types of foam that comply with the French standard for ski runs.

PU foam

Most widely used foam for making pads (cost-effective).

PE foam

Foam that has the advantage of being waterproof, which prevents ice from forming inside the pad if the cover is torn by skis.

Advantages with PU FOAM

Density 22 kg/m³

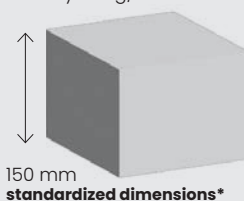

Cost-effective solution



Different preformed shapes available

NF S52-105

RFID and NFC chips and XML file for tracking



*Other thicknesses available

Advantages with PE FOAM

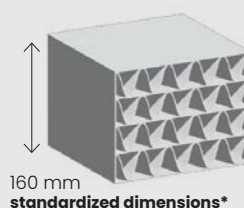

Water-repellent



Lighter



100% recyclable

NF S52-105

RFID and NFC chips and XML file for tracking

04. Choose the shape

We can create foam pads in custom shapes (subject to minimum order quantities) or adapt our standard foam designs by adjusting the width and height.

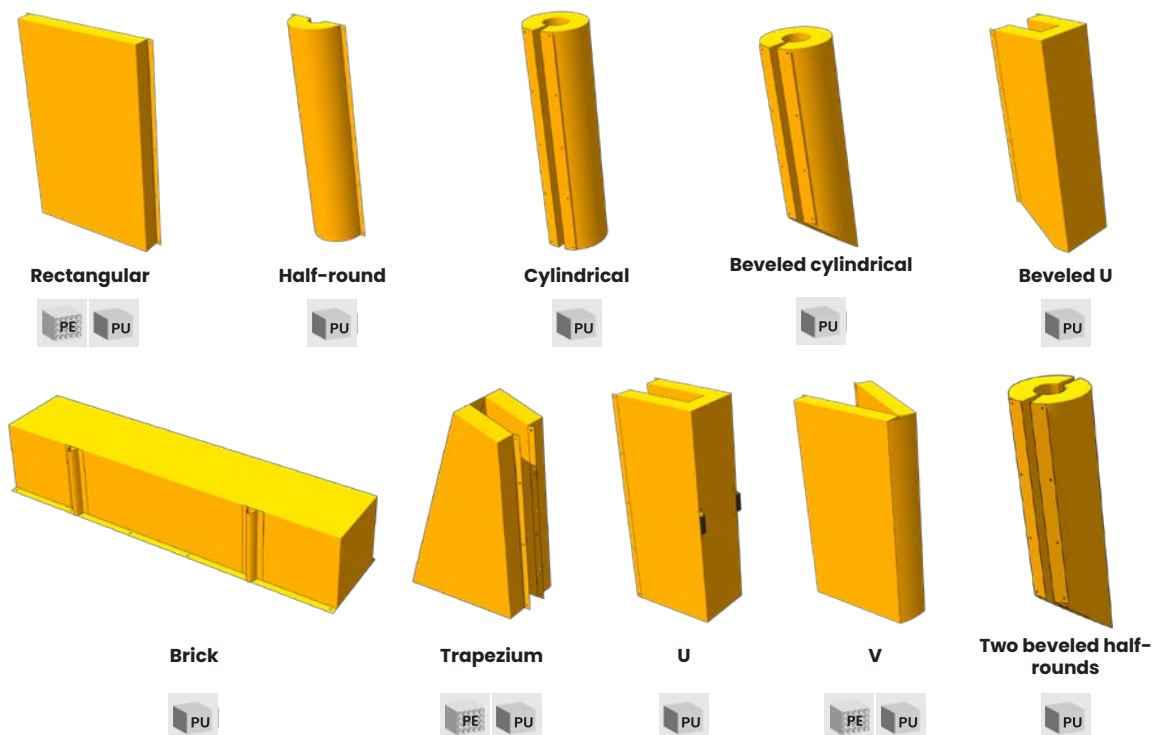



05. Choose the options

Several options are available on request. Our experts will guide you in choosing the options best suited to your needs.

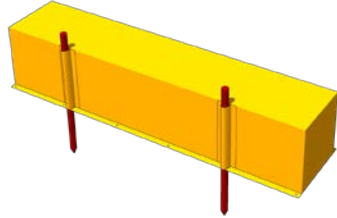

Anchor pole sleeves

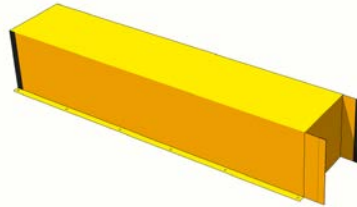

Flaps with or without hook-and-loop strips

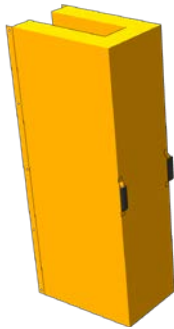

Lifting handles



Straps

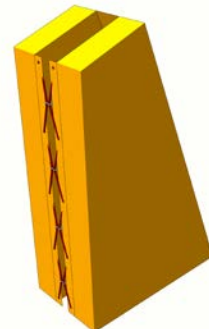

Eyelets and bungees



Standard crash pads

MADE IN FRANCE
Certified by an independent
auditor



With eyelets, radio-frequency welded seams, perfectly waterproof and supplied with mounted attachment accessories and standard-compliant markings.

Rectangular

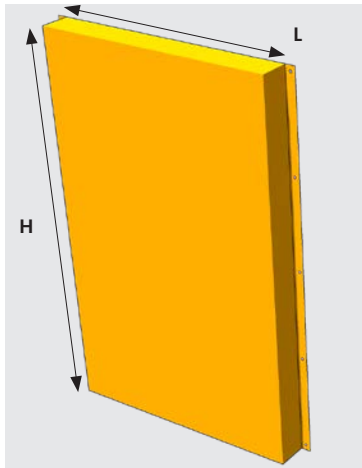

M*

FOR 300 X 300 MM
CUSTOM PRINTING

Add an "M" after the basic ID



E.g. ID MAT830M

MBS EXPERT'S
TOP TIP

Send us your vector-
ized logo and its po-
sition before placing
your
order!

Dimensions (mm)

Preformed rectangular pad - PU

H x L	TH.	Mat.	Low-slip		M*
					
2000 x 250	150	PU	MAT830	MAT930	IDM
2000 x 500	150	PU	MAT831	MAT931	IDM
2000 x 750	150	PU	MAT832	MAT932	IDM
2000 x 1000	150	PU	MAT833	MAT933	IDM
2000 x 1200	150	PU	MAT834	MAT934	IDM
2000 x 1500	150	PU	MAT835	MAT935	IDM
2000 x 2000	150	PU	MAT836	MAT936	IDM

Preformed rectangular pad - PE

2000 x 250	160	PE	MAT602	MAT603	IDM
2000 x 500	160	PE	MAT606	MAT607	IDM
2000 x 750	160	PE	MAT610	MAT611	IDM
2000 x 1000	160	PE	MAT614	MAT615	IDM
2000 x 1200	160	PE	MAT618	MAT619	IDM
2000 x 1500	160	PE	MAT622	MAT623	IDM
2000 x 2000	160	PE	MAT626	MAT627	IDM



Preformed cylindrical

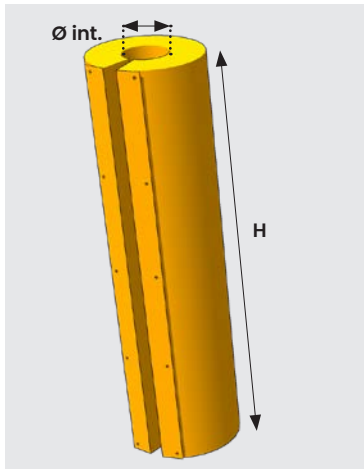

Dimensions (mm)		Preformed cylindrical pad			
H x Ø int.	TH.	Mat.	Low-slip	Low-slip	M*
2000 x 60	150	PU	MAT850	MAT950	IDM
2000 x 100	150	PU	MAT837	MAT937	IDM
2000 x 150	150	PU	MAT851	MAT951	IDM
2000 x 200	150	PU	MAT838	MAT938	IDM

Preformed two half-rounds

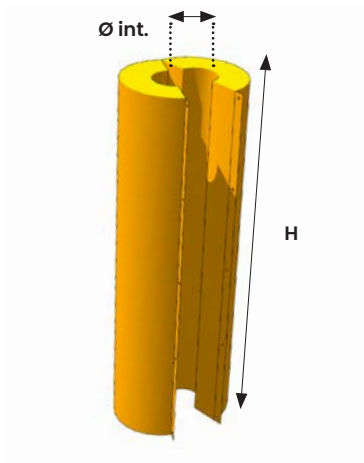

Dimensions (mm)		Preformed pad with two half-rounds			
H x Ø int.	TH.	Mat.	Low-slip	Low-slip	M*
2000 x 60	150	PU	MAT894	MAT994	IDM
2000 x 100	150	PU	MAT895	MAT995	IDM
2000 x 150	150	PU	MAT879	MAT979	IDM
2000 x 200	150	PU	MAT898	MAT998	IDM

Preformed half-round

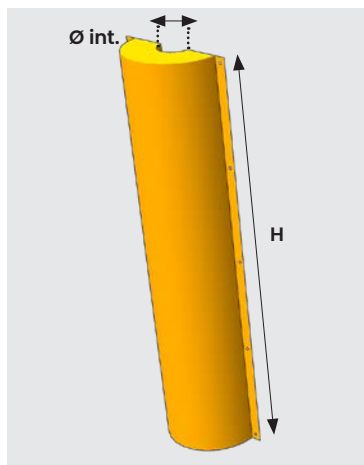

Dimensions (mm)		Preformed half-round mat			
H x Ø int.	TH.	Mat.	Low-slip	Low-slip	M*
2000 x 100	150	PU	MAT860	MAT959	IDM
2000 x 100	150	PU	MAT861	MAT960	IDM
2000 x 150	150	PU	MAT862	MAT961	IDM

safety

Standard

crash pads for snow cannons and towers

MADE IN FRANCE
Certified by an independent auditor



◆ Crash pads for snow cannon bases

"V"

Suitable for snow cannon bases

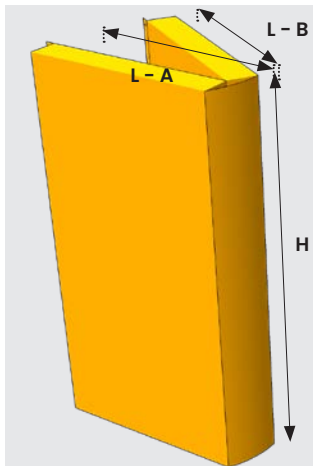

Dimensions (mm)			Snow cannon crash pads - "V"				
H	L - A internal	L - B internal	TH.	.	Low-slip	Low-slip	
2000	1000	1000	150	PU			MAT845 MAT945 IDM

"U"

Suitable for snow cannon bases

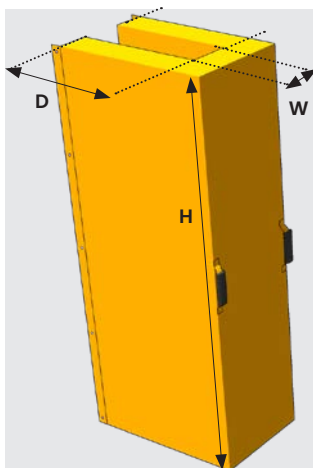

Dimensions (mm)			Snow cannon crash pads - "U"				
H	D internal	W internal	TH.	b	Low-slip	Low-slip	
2000	600	200	150	PU			MAT859 MAT962 IDM
2000	800	200	150	PU			MAT840 MAT940 IDM
2000	1200	200	150	PU			MAT897 MAT997 IDM

OPTION

Carrying handles for U-shaped mats, ID:
MAT963

Standard crash pads for snow cannons and towers



◆ Pads for upper sections

Note: Different possibilities for the upper section, depending on the snow cannon model
The stated dimensions are the internal dimensions

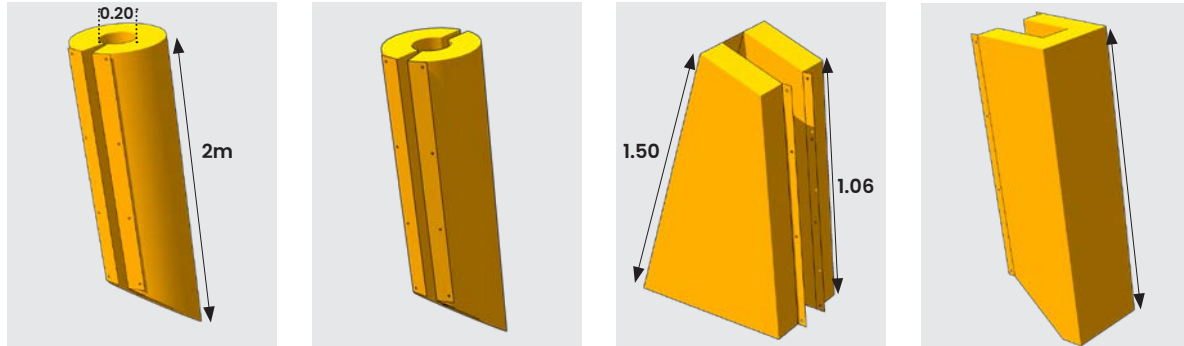

Beveled cylindrical

2 beveled half-rounds

Trapezium

Beveled U

Model	TH.	Mat.	Low-slip		IDM
			●	●	
A . Beveled cylindrical	150	PU	MAT868	MAT968	IDM
B . 2 beveled half-rounds	150	PU	MAT896	MAT996	IDM
C . Trapezium	150	PU	MAT844	MAT944	IDM
D . Beveled U	150	PU	MAT873	MAT973	IDM

◆ Tower pads

With ladder access door. 2 side pads connected with a central pad that can be used as a door

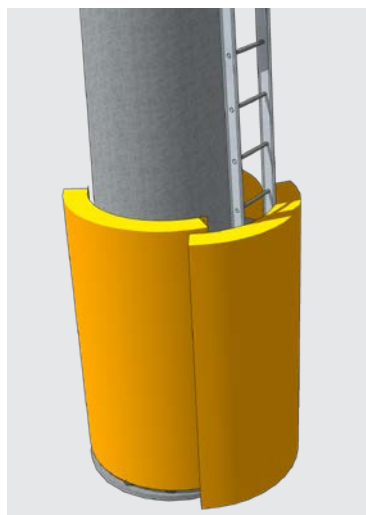

Note: the pads supplied are rectangular and flat. When fitting, they can be deformed slightly to mold to the tower's shape.

Tower H x Ø int.	TH.	Mat.	Low-slip		IDM
			●	●	
Tower 800 2000 x 1100 (x1) 2000 x 800 (x2)	150	PU	MAT883	MAT983	IDM
Tower 900 2000 x 1200 (x1) 2000 x 900 (x2)	150	PU	MAT884	MAT984	IDM
Tower 1000 2000 x 1300 (x1) 2000 x 1000 (x2)	150	PU	MAT885	MAT985	IDM
Tower H x Ø int.	TH.	Mat.	Low-slip		IDM
			●	●	
Tower 800 2000 x 1100 (x1) 2000 x 800 (x2)	160	PE	MAT636	MAT637	IDM
Tower 900 2000 x 1200 (x1) 2000 x 900 (x2)	160	PE	MAT640	MAT641	IDM
Tower 1000 2000 x 1300 (x1) 2000 x 1000 (x2)	160	PE	MAT644	MAT645	IDM

signage

safety

competition

leisure

facilities

safety

Standard crash pads for fun runs

PVC-covered pad with anchor pole sleeves. Supplied without poles.

MADE IN FRANCE
Certified by an independent auditor



NF
S52-105
Complies with standard



Brick pad Ideal for sled trails

The pad can be anchored to the ground using polycarbonate poles

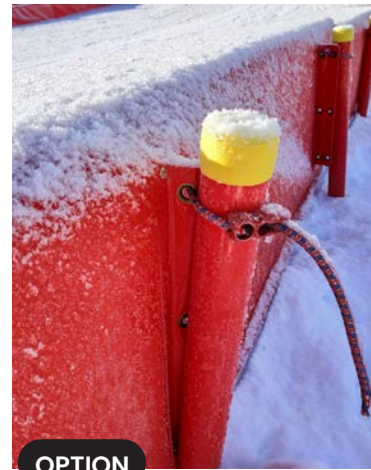
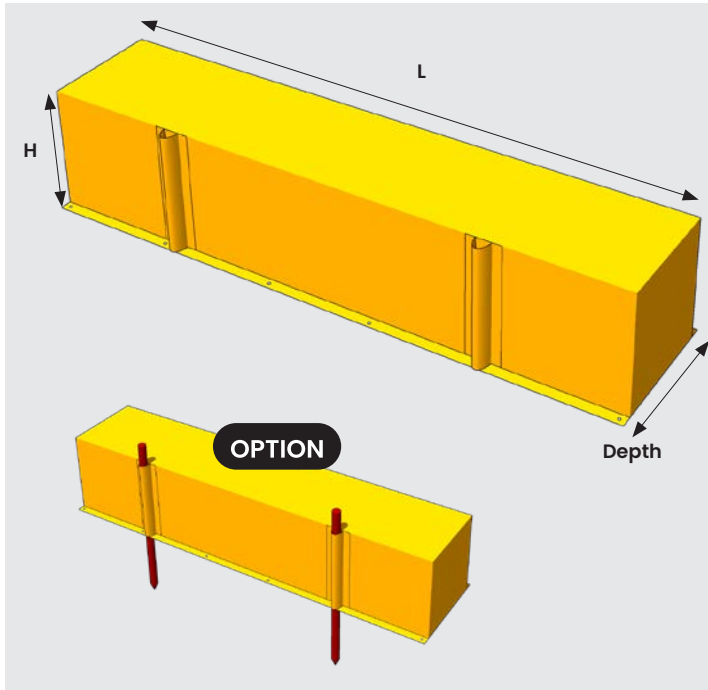

Polycarbonate poles
Ø 48 mm / H 1 m
Tapered tip and end cap
Color: ● Red

PIQ256A

Note:
number of poles required
for 2500 mm = 2
for 4000 mm = 3

Dimensions (mm)

Crash pad for sled trails

H x L x D	Mat.	Low-slip	Low-slip	Smooth cover	
		●	●	●	
500 x 2500 x 500	PU	MAT866	MAT967	MAT552	IDM
500 x 2500 x 150	PU	MAT889	MAT989	MAT550	IDM
500 x 4000 x 150	PU	MAT890	MAT990	MAT551	IDM



Accessories



Manual eyelet press
supplied with 1,000 eyelets

DIV187



Eyelets for manual press
Quantity: 1000 eyelets

Ø 8 mm
DIV188



Symmetrical S hooks ZN
Quantity: 100

ACC122



Flecked bungee cord

Dimensions l x Ø	Colors	Ref.
100 m x Ø 8 mm	Red	ACC108
100 m x Ø 8 mm	Green	ACC185
100 m x Ø 8 mm	Blue	ACC186



Closed cell foam tubing L 2 m

Dimensions l x Ø	Ref.
2 m x inner Ø 60 mm	MAN100
2 m x inner Ø 100 mm	MAN101



MBS EXPERT'S TOP TIP
protect your crash pads in summer with our custom protections. Contact us to find out more.



Discover **our crash pad factory**

All our crash pads are manufactured at our premises
in Tours in Savoie, 73.



01.



02.



03.



04.



05.



06.



07.



08.



09.



10.



11.

01. Unrolling and cutting 02. Rolling tarpaulin to send for welding 03. Welding tarpaulin edges on 3 sides 04. Adding eyelets to welds 05. Storing tarpaulins before covering foam 06. Foam selection 07. Covering the pad 08. Sealing the final edge of the pad 09. Installing accessories 10. Stacking pads 11. Factory

signage

safety

competition

leisure

facilities

Poles

medium Ø25 bamboo



Complies with standard

Packaged in bundles of 25

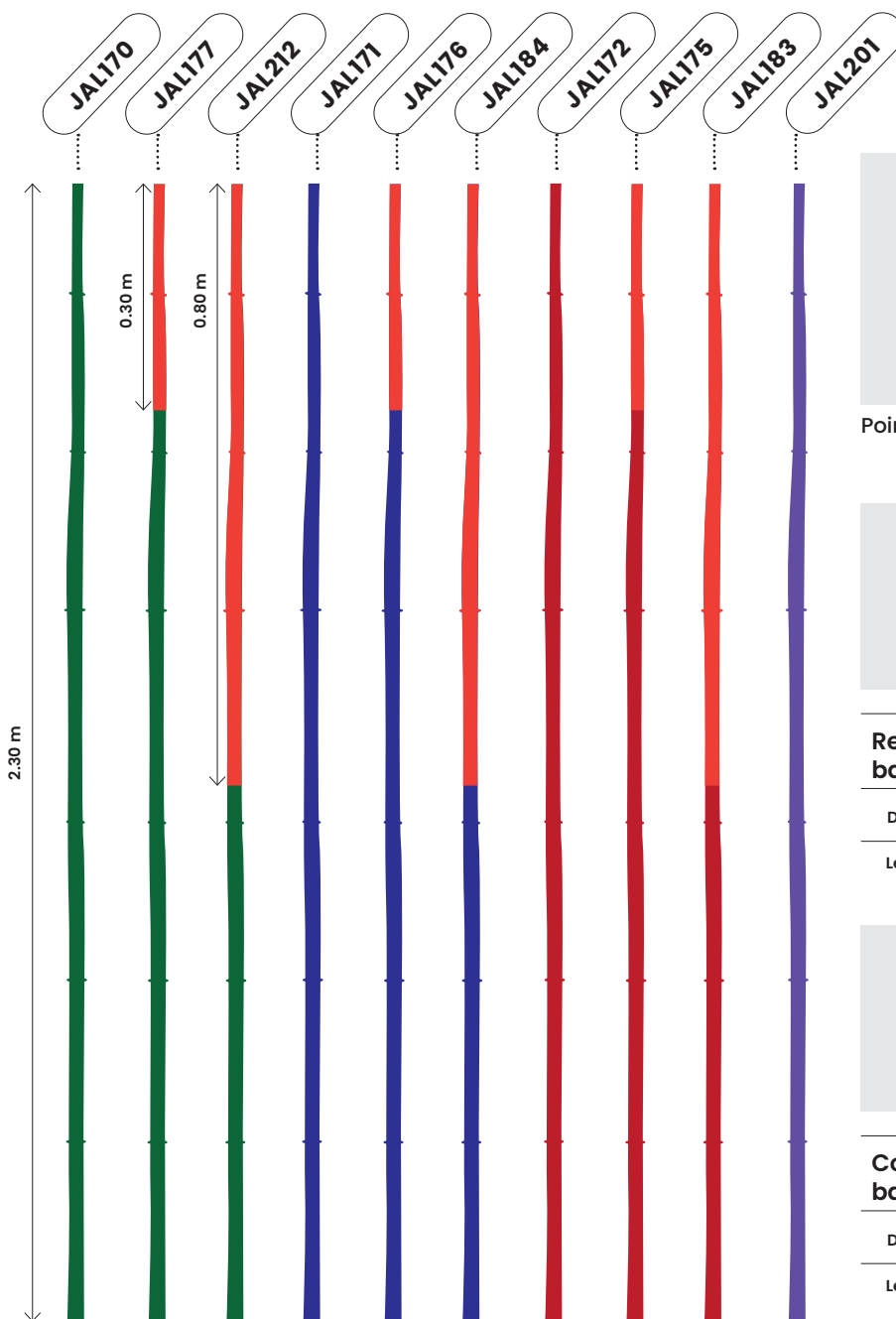

Pointed tip



Retractable end for bamboo poles

Dimensions	Ref.
Length 250 mm Ø 15 mm	257596



Coiled strip for bamboo poles

Dimensions	Ref.
Length 250 mm Ø 15 mm	JAL104

Medium Ø25 bamboo poles

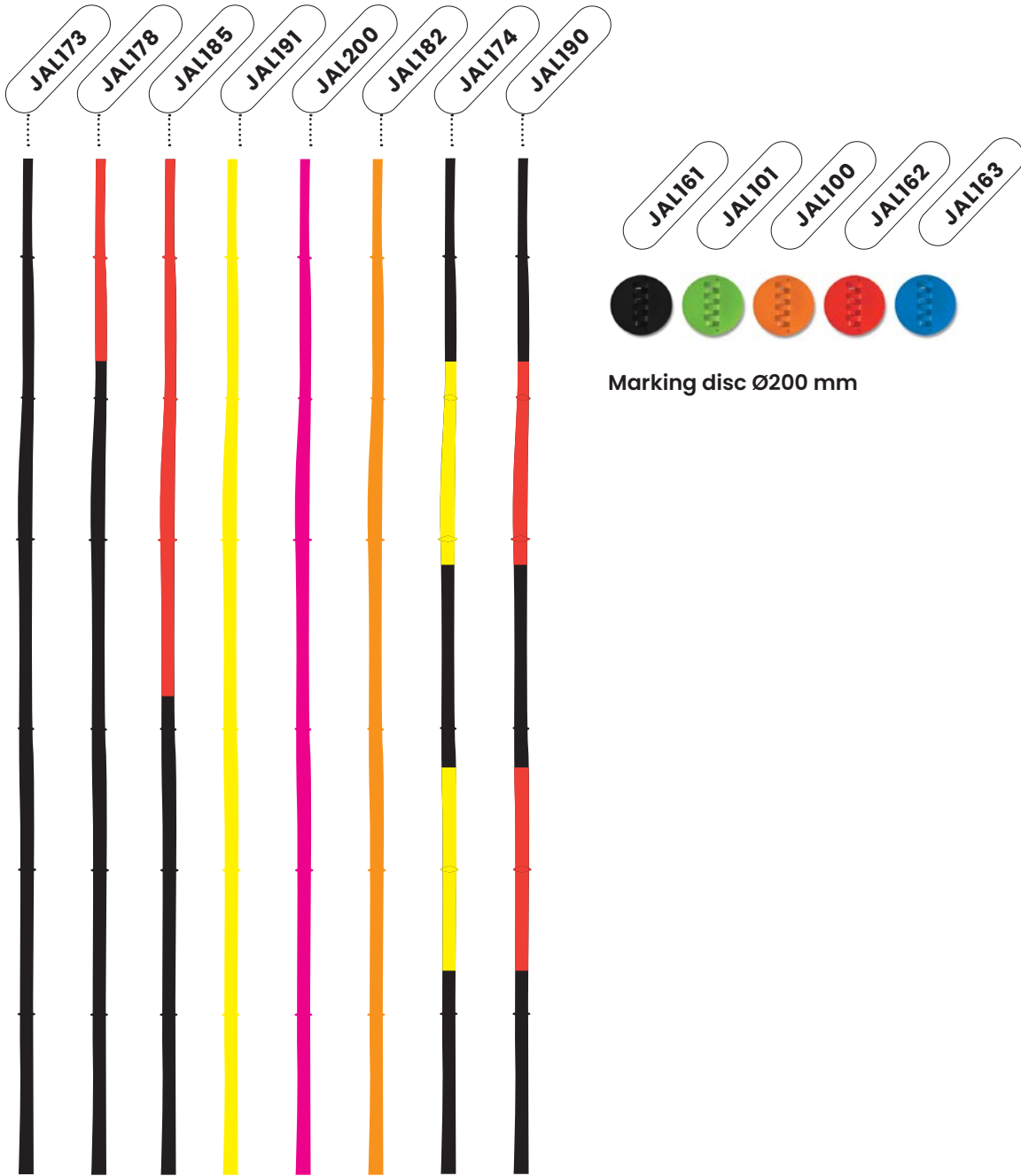

signage

safety

competition

leisure

facilities

Poles

polycarbonate Ø25 with screw tip



Packaged in bundles of 20

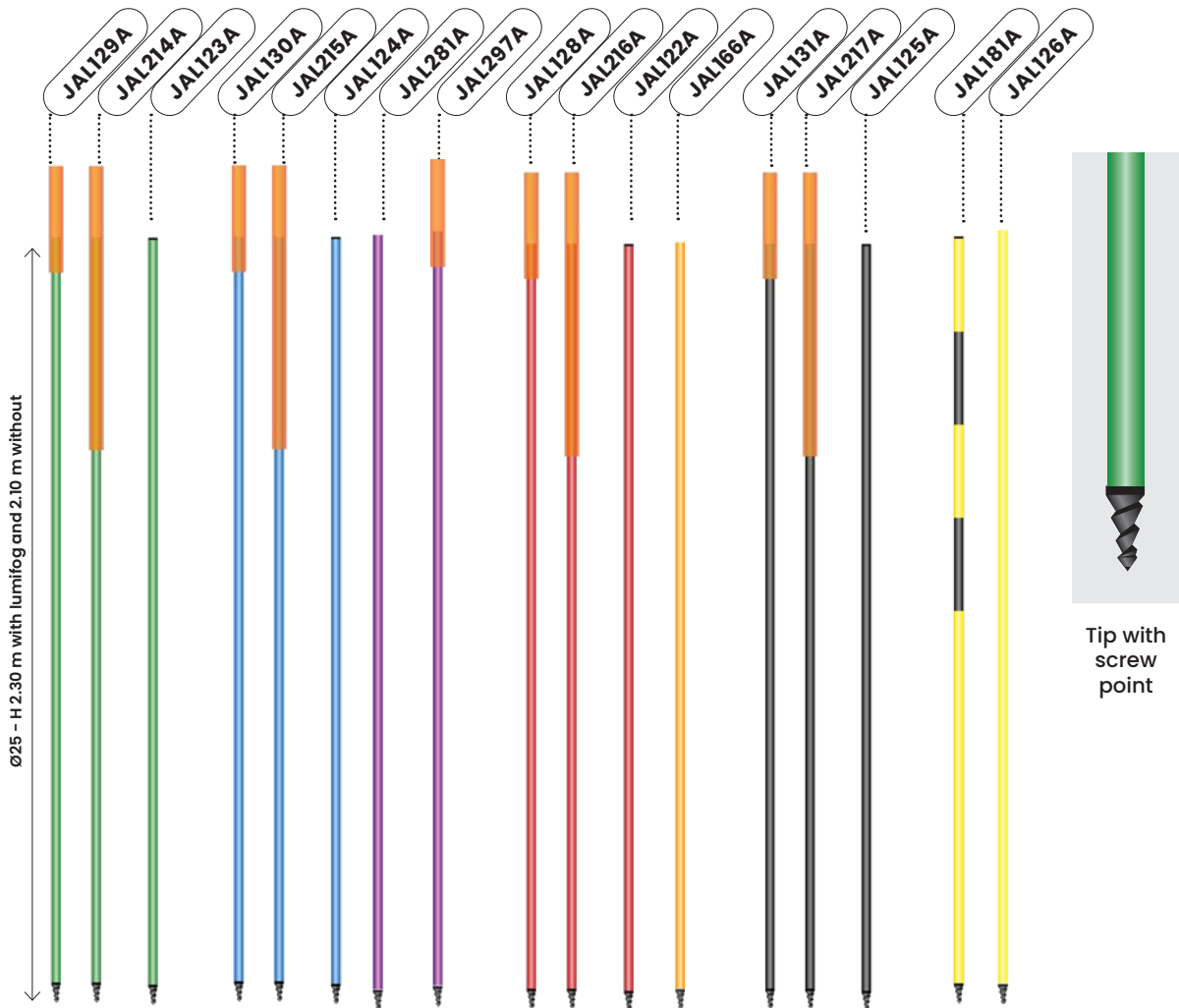

Polycarbonate post accessories Ø 25

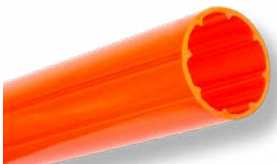

Lumifog PC UV performance guaranteed / Long-lasting fluorescence

Dimensions	Ref.
800 mm - Ø 25	JAL226A
300 mm - Ø 25	JAL148A



Star

Dimensions	Ref.
Ø 25 mm	MP3871127



Reflective tape

Dimensions	Ref.
L 45 m x H 5 cm	COR165

Polycarbonate poles Ø25



Poles

polycarbonate Ø25 with point and hinge

Packaged in bundles of 20

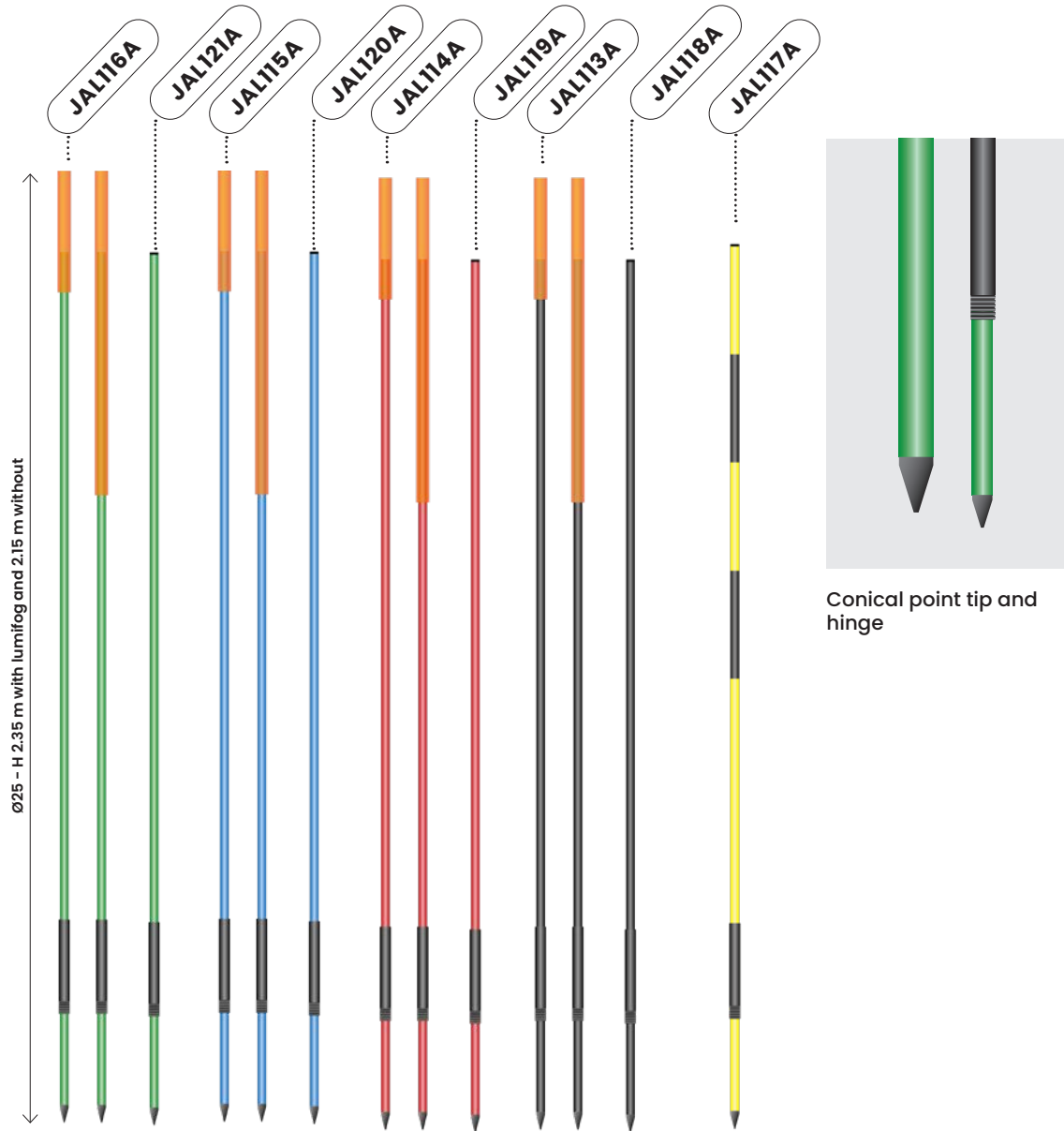

signage

safety

competition

leisure

facilities

safety



Polycarbonate poles Ø25



Poles

polycarbonate Ø25 with reflective strip and screw point

Packaged in bundles of 20

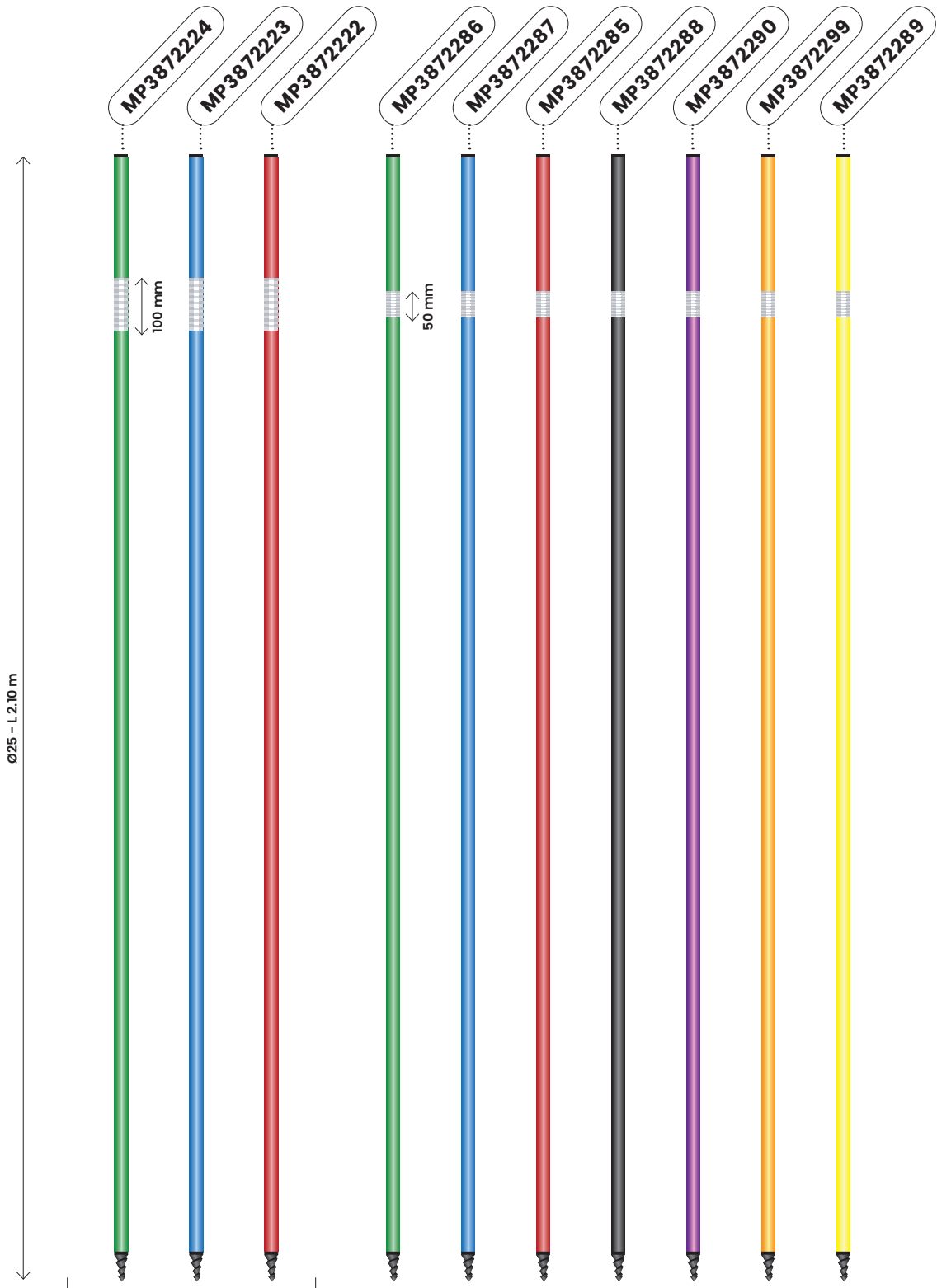

Advice from MBS expert:
Ideal for route marking"

signage

safety

competition

leisure

facilities



safety

Posts

made from polycarbonate Ø60 & Ø48



HIGH STRENGTH. Ø 60 and Ø 48: Diameter provides maximum strength, ideal for installing net or rope. Meets safety standards.

Not pointed

with plug

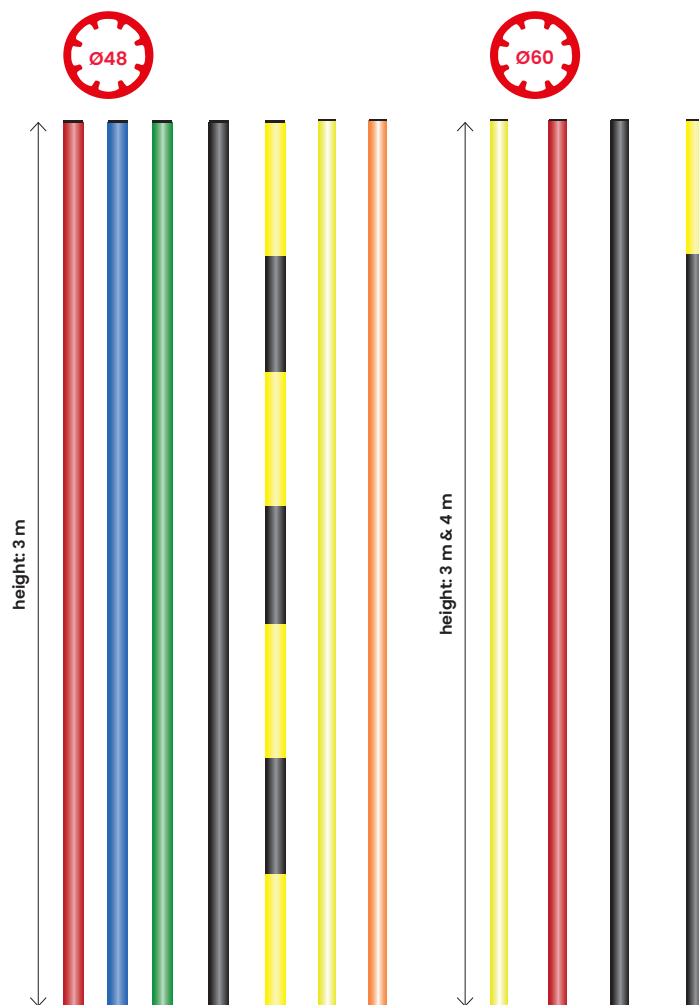

For slide arrest anchors, and other colors and lengths, contact us

Accessories



Black clamp with fixings

Dimensions	Ref.
Ø 60 mm	PIQ195
Ø 48 mm	PIQ151



Black clamp with fixings

Dimensions	Ref.
Ø 60 mm	PIQ195
Ø 48 mm	PIQ151



Fixing clip ideal for tape

Dimensions	Ref.
Ø 60 mm	COM933

while stocks last

h x Ø	Mat.	Red	Blue	Green	Black	Yellow & Black	Yellow	Orange
3000 X 48	PC	PIQ270A	PIQ271A	PIQ272A	PIQ273A	PIQ274A	PIQ293A	PIQ290A
3000 X 60	PC	PIQ173A	-	-	-	PIQ220A	PIQ400A	-
4000 X 60	PU	PIQ177A	-	-	PIQ180A	PIQ221A	-	-

Posts made from polycarbonate Ø60 & Ø48



Accessories



Illuminated post
PC post Ø48, Height 2 m, reflective strip. Delivered with solar lamp, metal brace, and triangle with fastening clamp.

DIV191



Flashing solar lamp, with ON/OFF button
Ø72 - H 150 mm suitable for Ø48 posts

DIV145

Fittings



Pointed galvanized base without plate

Ø 60 mm

PIQ225

Ø 48 mm

COM339



Pointed galvanized base with plate

Ø 60 mm

PIQ226

Ø 48 mm

PIQ154



Base with integrated anti-rotation brace (limited stock)

Ø 60 mm

FUN010



Part for striking to install bases

Ø 60 mm

JAL186

Ø 48 mm

JAL136



Anti-rotation base (brace)

Ø 60 mm

PIQ189

Ø 48 mm

PIQ155

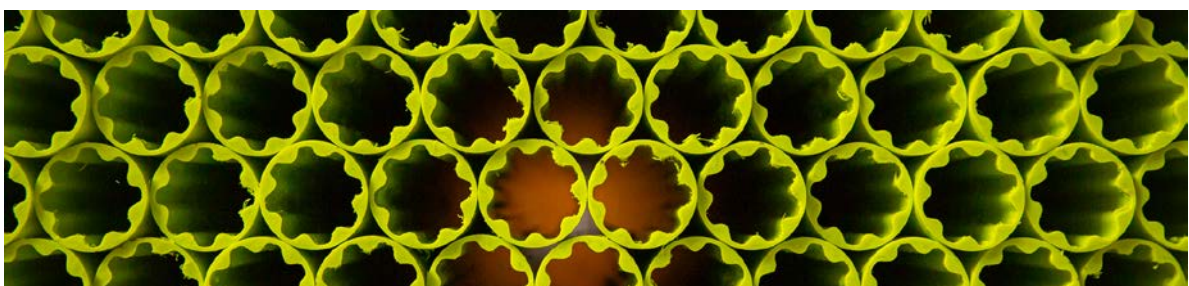

signage

safety

competition

leisure

facilities



Protection equipment

01. Study and preliminary design

We work alongside you during the preliminary design phase. Our teams support you on site, helping you define the solutions which need to be implemented, and taking your requirements and terrain into account with our knowledge and experience. In this way, you can create a budget and plan the work required.



02. Design

We have the ability to study your project and design innovative solutions which are suited to your needs.



03. Manufacture

We have a production tool which enables the vast majority of the products we provide to be non-standard. Our partner subcontractors also work alongside us to provide you with a comprehensive solution.



04. On-site installation

We offer installation support: from technical assistance to help your teams implement our products, through to installation by specialist teams, site supervision, and receipt. MBS's experience enables our sales and technical teams to support you through every phase of a project, from study to receipt.



World cup "R" type support poles



World cup standard support poles



"C" poles



Lamp-post poles



Straight support poles



Modulo (r)

signage

safety

competition

leisure

facilities



FIS type "A" net protection

More than 30 years of know-how



We began developing our know-how with ADIC in the 80s. Our ability to design, manufacture, and install enables us to produce ready-to-use FIS type "A" net solutions, meeting the needs of the biggest competitions. We provide support, from the homologation report through to receipt of your protection.

Previous work

TIGNES: 140 m + 270 m protection at Lognan stage

ROSA KHUTOR: 5,000 m for Sochi 2014 Olympics

FONT ROMEU: 100 m slalom stage (2014)

FONT ROMEU: 300 m protection at stage (2015)

VAL THORENS: Ski cross World Cup (2015)

FONT ROMEU: 100 m protection at stage (2016)

ISOLA 2000: French Championship at new competition stage (2019)

JACKSON HOLE: US and FIS Circuit - ELK slope (2019)

ORCIÈRES: Speed European Cup - Camille Ricou slope (2020)

MÉRIBEL: World Championship - Roc de Fer slope (2023)

CHÂTEL: 110 m protection on speed slope at Linga - World Championship (2024)

CRANS MONTANA: 2,300 m protection on Nationale slope - World Championship 2027

Different poles:



1

World Cup
standard
support poles
with guy wires



2

Self-stabilizing AS World
Cup support poles
(fixed support pole)
Anchoring depends on the
characteristics of the terrain



3

World cup "R" type
support poles



4

Anchoring
depending on
the characteristics
of the terrain

Different options



Double nets on
separate wires



Lifting winch

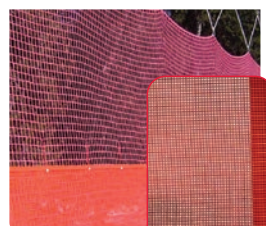

Sliding
panel

FIL239

FIL239L



Anti-UV panel

252881

FIS type "A" net protection



signage

safety

competition

leisure

facilities



Protection "C" poles



"C" poles

"C" poles can be positioned 12 to 15 m apart, depending on the configuration of the line (straight or curved), the type of net used (more or less wind-proof), and the terrain. They are also very safe, with a pole net-hanger distance of more than 3 m. These poles may be used in competition technical events (giant or slalom).

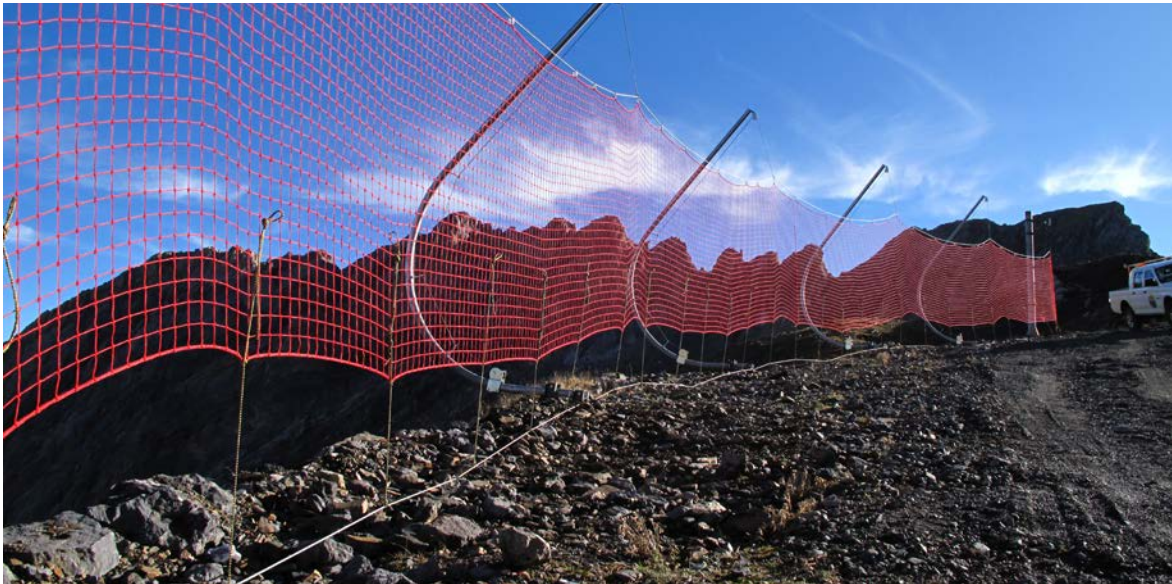

Different options



Rail at the base of the net
standard 0.4 m to 1 m snow level optimization and maintenance, higher level upon request



Straight pole, lamp-post pole, and modulos combination



Lifting winch

COM586



Anti-UV panel

252881

Protection

Lamp-post poles

Lamp-post poles

MBS lamp-post poles can be positioned 8 to 10 m apart, depending on the configuration of the line (straight or curved) and the type of net used (more or less wind-proof). They can be placed at a safety distance of around 1 meter between the net and the pole.



Different options



Rail at the base of the net
standard 0.4 m to 1 m snow level optimization and maintenance, higher level upon request



Straight pole, lamp-post pole, and modulus combination



Struts



Lifting winch

COM586



Anti-UV panel

252881

“Lamp-post” pole protection

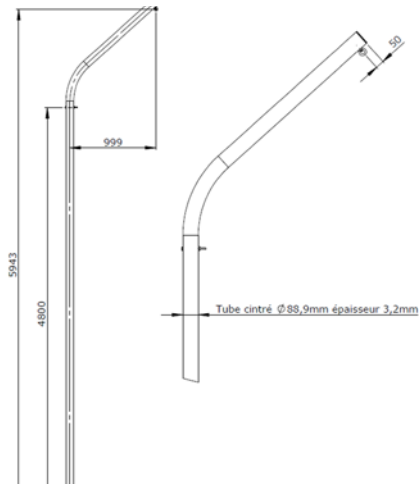
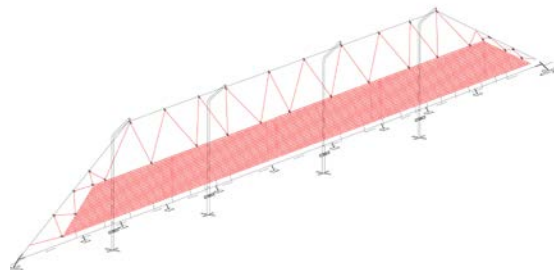
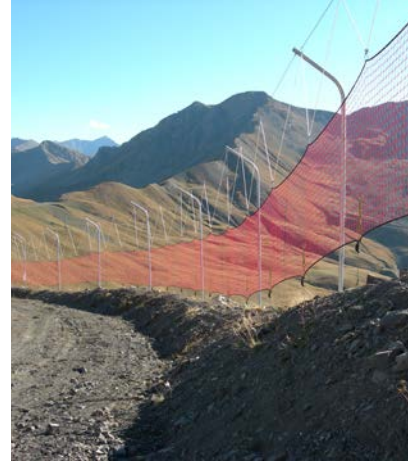

signage

safety

competition

leisure

facilities



Protection

Straight support poles

Straight support poles

Protection which uses straight support poles still provides the best value in fixed net protection, but their use depends on the slope and implementation. A sliding clamp system can be added to enable the height of the net to be adjusted easily.



Different options



Rail at the base of the net
standard 0.4 m to 1 m snow level optimization and maintenance, higher level upon request



Straight pole, lamp-post pole, and modulos combination



Lifting winch

COM586



Anti-UV panel

252881

Other options available upon request

Straight support pole protection



signage

safety



competition

leisure

facilities

Modulo®

Widening solutions

To widen access routes (ski slopes, paths, banks, cycle tracks) with a simple, modular installation, depending on the requirements of the terrain.

System developed and certified by T.A.S., consisting of a cage (where the ballast is placed) and a cantilevered section which enables the route to be widened.

Technical characteristics

MATERIAL

- Crude steel/Hot-dip galvanized steel
- Use of class 3 wood (larch) or class 4 autoclave treated wood
- Possible use of local materials for backfilling

DIMENSIONS

- Length 5.5 m
- Width 2 m
- Height 0.9 m (Only one model available)

MAXIMUM WEIGHT SUPPORTED

- 10 metric tons
- 1 meter of snow at 500 kg/m



Operational advantages

READY-TO-USE

This structure (<800 kg), which can be transported by helicopter, is installed very quickly, and most often includes the re-use of cleared materials, effectively reducing earth-moving works.

Ratio of cleared/backfill material next to zero.



EASY INSTALLATION AND REDUCED WORKS



MODULAR

Installing this solution to a greater or lesser depth, depending on the requirements of the terrain (underground networks, topography), enables the route to be widened by an average of 3.5 meters, even in tricky mountain areas.

Particularly suitable for use after a steep slope and ahead of a cliff



SUITABLE FOR SLOPES WHICH RUN ALONG RIVERS AND MECHANICAL SKI LIFT BOARDING AREAS



Benefits

STABILITY

No accentuation of destabilization phenomenon as, unlike with traditional solutions, no significant supplementary excess load is exerted on the bank ahead of it.



PERFORMANCE OVER TIME

SKIER PROTECTION

Option to integrate skier protection in line with standards NF52105/NF52106 for ski slopes, which also enables the snow level on the slope to be enforced.



OPTIMIZATION OF ARTIFICIAL SNOW PRODUCTION

BEFORE



AFTER



Chamonix, Brévent



Saint Lary



Les Arcs

signage

safety

competition

leisure

facilities

Safety nets



FIS nets - type "A"

Competition

Red HD polyethylene with \varnothing 12 mm reinforcement,
For any non-standard dimensions (length, height, mesh, braid), please
get in touch. Limited stock of standard products.

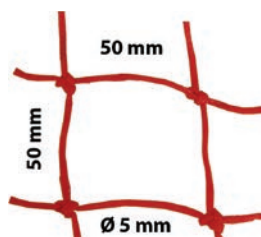

NF S 52106 S2
HD POLYETHYLENE
Red with reinforcement

$\longleftrightarrow \times \updownarrow$	ID	$\longleftrightarrow \times \updownarrow$	ID
25 m x 4 m	FIL655	25 m x 3 m	255731
50 m x 4 m	FIL692	50 m x 3 m	255732
20 m x 4 m	255729	20 m x 3 m	255733
30 m x 4 m	255730	30 m x 3 m	255734

Protection nets

Leisure downhill skiing

Red HD polyethylene with \varnothing 10 mm reinforcement. For any non-standard dimensions (length, height, mesh, braid), please get in touch. Limited stock of standard products.

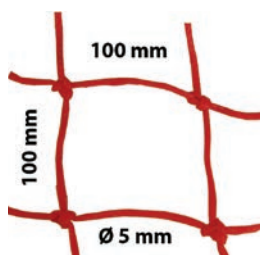

NF S 52106 S1
HD POLYETHYLENE
Red with reinforcement

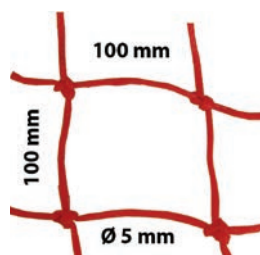

NF S 52106 S2
HD POLYETHYLENE
Red without reinforcement

$\longleftrightarrow \times \updownarrow$	ID
25 x 1.30 m	FIL131
50 x 1.30 m	FIL225
25 x 1.50 m	FIL650
50 x 1.50 m	FIL658
25 x 2.00 m	FIL230
50 x 2.00 m	FIL231
25 x 2.50 m	FIL255
50 x 2.50 m	FIL256
25 x 3.00 m	FIL637
30 x 3.00 m	FIL652
40 x 3.00 m	FIL653
50 x 3.00 m	FIL638

$\longleftrightarrow \times \updownarrow$	ID
25 x 1.50 m	FIL657
50 x 1.50 m	FIL658
25 x 2.00 m	FIL659
50 x 2.00 m	FIL660

Anti-UV panel

Dark green shade net with fabric border and v160 eyelets every 50 cm. To protect the nets in summer. Dimensions: 18 m x 1.50 m



252881



Accessories

All the essentials for your netting lines



**Red PA rope
High tension**

Ø 10mm
1 200 m

COR156



**PE rope
Yellow/black**

Ø 09mm
1 200 m

COR146



**MBS
swivel pulley**

ACC210



Carabiner

Ø 11 mm

ACC130



Quick link

Ø 8 mm

ACC129



**"World Cup"
sliding panel**

25 x 2.25 m
1 200 m

anti-perforation
made using an
openwork woven
PVC mesh and
tempered
steel wires

FIL239

FIL239L

Available for rental



**Panel
attachment**

ACC106



**Low tension
lock**

ACC209



Check out our
Ø60 and Ø48
polycarbonate
poles on p100
for your net
installations.

Safety nets



FIS nets - type "B" Competition

Red HD polyethylene with \varnothing 12 mm reinforcement. For any non-standard dimensions (length, height, mesh, braid), please get in touch. Limited stock of standard products.



NF S 52106 S2
HD Polyethylene
Height 2 m



	ID	Poles	Color	Length	Fitting	Designation
<p>Ø35 - L.2.50 m</p> <p>PIQ162A</p>	FIL600	x0	●	20 m	x0	Net only
	FIL671	x11	●	20 m	x22	Assembled net
	FIL672	x11	●	20 m	x22	Net kit NOT assembled
	FIL673	x11	●	20 m	x22	Assembled net
	FIL674	x11	●	20 m	x22	Net kit NOT assembled
	FIL671L	x11	●	20 m	x22	RENTAL Assembled net
	FIL801	x8	●	15 m	x16	Assembled net
	FIL833	x0	●	20 m	x0	Net only
	FIL834	x11	●	20 m	x22	Assembled net

Please note: blue color not homologated in France

FIS nets - type "B-C" Competition

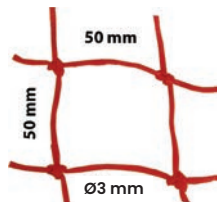

NF S 52106 S2
HD Polyethylene
Height 1.30 m



	ID	Poles	Color	Length	Fitting	Designation
<p>Ø35 - L.1.175 m</p> <p>PIQ258A</p>	FIL675	x0	●	20 m	x0	Net only
	FIL676	x11	●	20 m	x22	Assembled net
	FIL678	x11	●	20 m	x22	Assembled net
	FIL679	x11	●	20 m	x22	Net kit NOT assembled
	FIL677	x11	●	20 m	x22	Net kit NOT assembled
	FIL676L	x11	●	20 m	x22	RENTAL Assembled net



Delimitation nets

FIS nets - type "C" Competition

Red HD polyethylene with \varnothing 12 mm reinforcement. For any non-standard dimensions (length, height, mesh, braid), please get in touch. Limited stock of standard products.

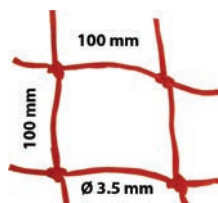

HD Polyethylene
Height 1.30 m

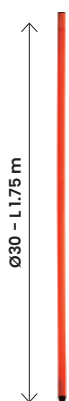

PIQ259A

ID	Poles	Color	Length	Fitting	Designation
FIL192	x0	●	20 m	x0	Net only
FIL681	x6	●	20 m	x12	Assembled net
FIL681B	x6	●	20 m	x12	Assembled net
FIL682	x6	●	20 m	x12	Net kit NOT assembled
FIL681L	x6	●	20 m	x12	RENTAL Assembled net

NEW! For type C nets with Velcro fastening, please get in touch with



Fastening clip

\varnothing 30 mm

ACC211

\varnothing 35 mm

ACC173



White Velcro fastening strap

for nets

ACC183B

Delimitation nets

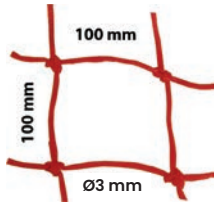

ID	Color	Dimensions	Nets installed on poles	
FIL257		10 x 1 m		x4
FIL260		25 x 0.50 m		x7
FIL189		25 x 1 m		x7
FIL193		25 x 1.30 m		x9
FIL191		50 x 1 m		x13
FIL195		50 x 1.30 m		x15

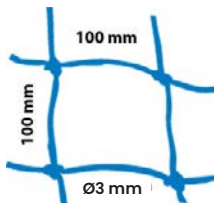

ID	Color	Dimensions	Nets installed on poles	
FIL796		10 x 0.40 m		x4
FIL832		10 x 1 m		x4
FIL244		25 x 1 m		x7
FIL691		25 x 1.30 m		x9



ID	Color	Dimensions	Nets installed on poles	
FIL610		25 x 1 m		x7





Barrier nets



ID	Color	Dimensions of mesh	Nets installed on poles
FIL159		25 x 0.30 m	x7

For other dimensions, please get in touch with us.



signage

Glass fiber poles

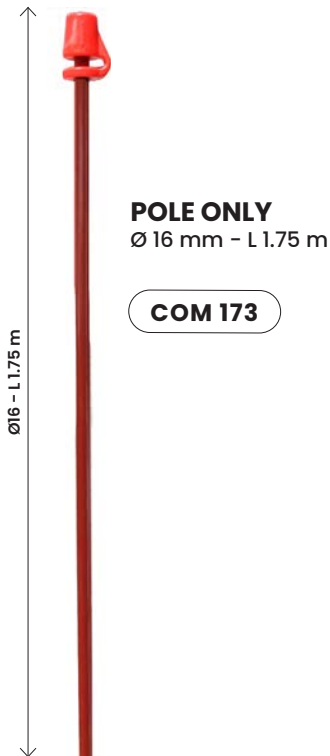

POLE ONLY
Ø 16 mm - L 1.75 m

COM 173

PIQ129K

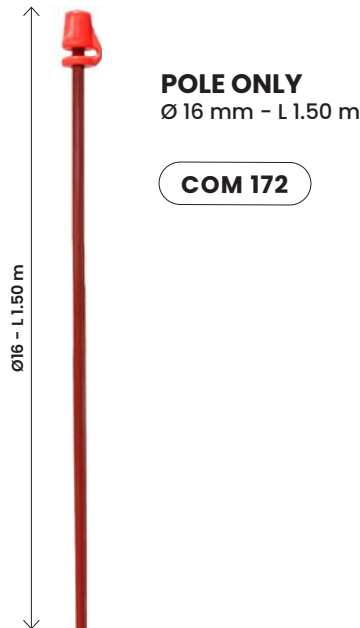

POLE ONLY
Ø 16 mm - L 1.50 m

COM 172

PIQ128K

safety

competition

leisure

Delivered with an end for striking, 1 ear clamp and 1 strap

facilities

Delimitation accessories

Accessories



Self-locking clip

Ø 5 mm

ACC104

Ø 8 mm

ACC105



Bungee cord with self-locking clip

L 700 mm - Ø 5 mm

ACC100

L 700 mm - Ø 8 mm

ACC101



Red bungee cable

200m - Ø 5 mm

ACC139

100 m - Ø 10 mm

ACC110



Red thread for net repairs

Ø 3.5 mm - 400 m

ACC136

Ø 3.5 mm - 400 m

ACC171

Ø 3.5 mm - 400 m

ACC182

Ø 3.5 mm - 500 m

ACC136B



End for striking for fiberglass pole (pack of 50)

Ø 16 mm

ACC159



Ear clamp for fiberglass pole (pack of 50)

Ø 15/18 mm

ACC117



Red strap (pack of 50)

100 x 15 mm

ACC120



Black rubber mallet

ACC160



Net unroller (only)

↕ 0.30 m

FIL100

↕ 0.50 m

FIL226

↕ 1.00 m

FIL227

Net unroller (only)

For closing ski slopes simply and quickly; includes a roller drum made of painted steel with net fastening, a pin to lock it in position, and bungee cord for tension at the end. Option for panel insert.

Fastening clamp for unroller

↕ 0.30 m to 0.5 m on Ø 76 mm to 120 mm pole

FIL2260

Delimitation tape



Fluorescent orange net texture tape

↔ 50 m x 50 mm

COR140



Reflective adhesive tape

↔ L 45 m x H 5 cm

COR165



Ropes and bungee cords



Yellow/black braided ropes

←→ 25 m - Ø 9 mm
x 11 (150 x 180 mm)

COR132



Single checked rectangle

←→ 150 x 180 mm

COR130



Single triangle in fluorescent orange openwork net

←→ 400 mm

COR133



Mountain ropes

←→ 120 m - Ø 4 mm

COR149

←→ 120 m - Ø 6 mm

COR152

←→ 120 m - Ø 8 mm

COR154



Cords made of cabled polypropylene - 100 m roll

Ø 8 mm

COR100

Ø 8 mm

COR103

Ø 8 mm

COR106

Ø 10 mm

COR101



Orange braided PE ropes

←→ 200 m - Ø 7 mm

COR144



Yellow/black braided PE ropes (on drum)

←→ 200 m - Ø 9 mm

COR146



Bungee cord + 11 floats

←→ 25 m - Ø 8 mm

COR135



Bungee cord + 11 floats

←→ 25 m - Ø 8 mm

COR176



Red float

COM114



Yellow/black braided PE ropes

←→ 200 m - Ø 12 mm

COR147



Red braided ropes for protection net tension

←→ 200 m - Ø 10 mm

COR156



Bungee rope (on reels)

←→ 100 m - Ø 8 mm

ACC170



Rope for avalanche control

←→ 100 m - Ø 6 mm

COR155

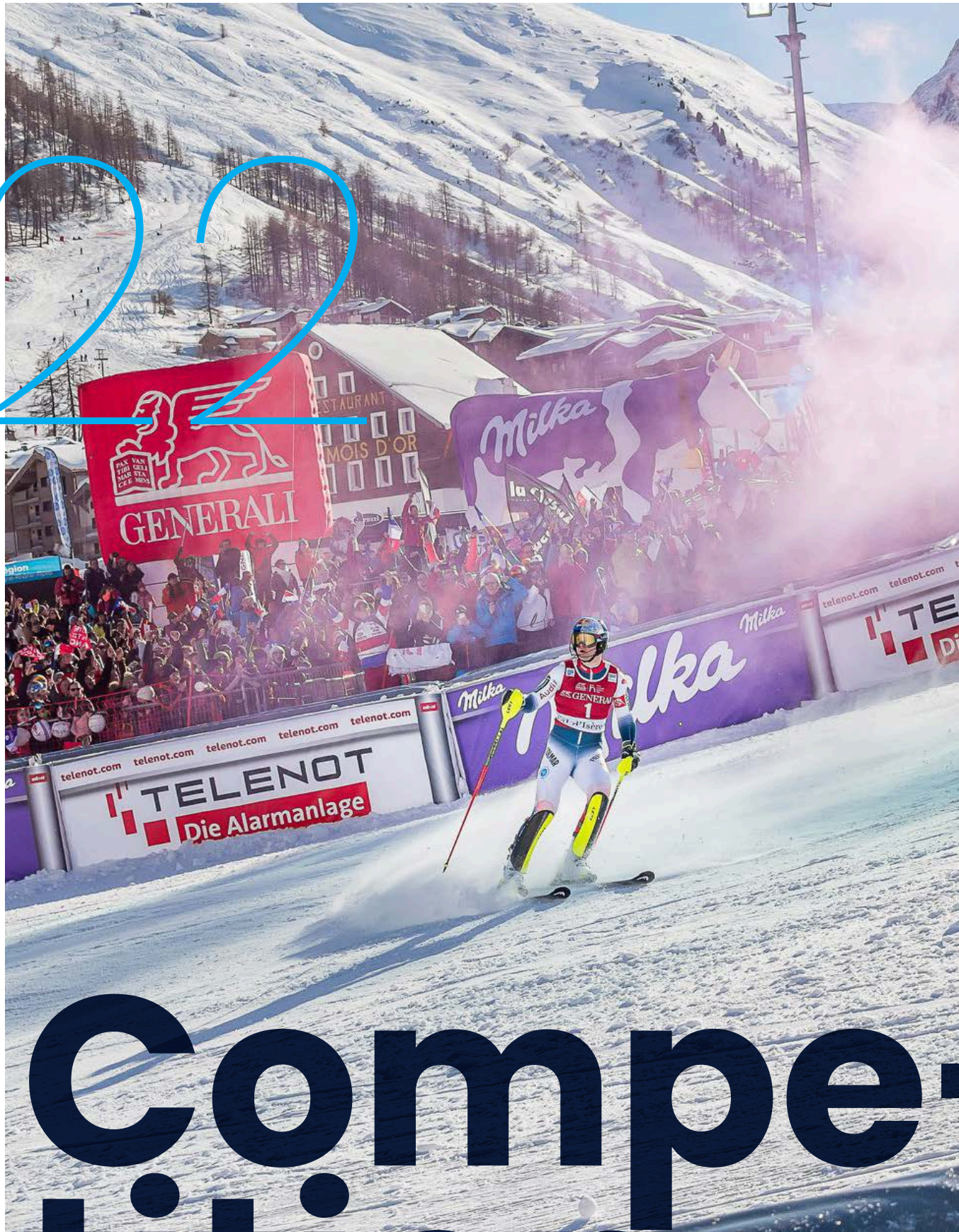

Competition

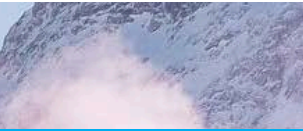

Rental equipment and services	P. 124
"CROSSGRIP" bases	P. 126
Poles	P. 127
Accessories	P. 134
Drills	P. 135
Competition banners	P. 136
Racing bibs	P. 138
Banners	P. 139
Timekeeping	P. 140

◆ MBS: BEST-FIT SOLUTIONS FOR YOUR EVERY NEED



Rental equipment and services

Organizing major sporting events, such World Cups or national championships, requires the installation of specific safety equipment for the duration of the events. For this reason, MBS provides a rental service for:

- a single gate system or automatic parallel system,
- timing (see page...)
- nets (FIS B, B-C and C nets),
- inflatable finish line enclosures (airpads) with pressure regulation,
- inflatable slope protection crash pads,
- a finish line,
- advertising framework/flags,
- competition poles with bases.

◆ MBS: BEST-FIT SOLUTIONS FOR YOUR EVERY NEED



Get in touch with us if you have other specific requests; we would be delighted to support you in organizing your events.





Inflatable finish line enclosures (airpads) with pressure regulation

MBS has developed a new range of autonomous Airpads with automatic pressure regulation. This solution has been tested at the University of Zaragoza Impact Laboratory, in accordance with the FIM protocol. The results obtained classify the new MBS safety device as category A, which is the highest level in terms of safety.

Inflatable slope protection crash pads

These pads are composed of cylindrical air compartments. They provide a high level of absorption and can be used, depending on the model, either as slope protection or finish line enclosures for the most elite international competitions.



Finish line

Advertising framework/ flags



Poles with bases

©Louis Garnier



MBS also provides an installation and removal service for rental equipment,

which can either provide assistance or take charge of all works. This comprehensive provision means organizers can have the benefit of the equipment provided, which meets current safety requirements, but still entrust this type of work to experienced technicians.

competition

"CROSSGRIP" bases

homologated



Long CROSS-GRIP base

PIAPPTBL

Cross-shaped brush with 6 branches and a diamond surface.
Easy to use, versatile, Ø35 hole in injected snow and Ø32 in non-injected snow.

Developed in collaboration with the French Ski Teams and the Savoie Ski Committee.

Hole diameter 35 mm
suitable for the softest snow.



Short CROSSGRIP base

PIAPPTBC

Similar technical characteristics.
Suitable for the thinnest layer of snow.



Competition poles

Hinged poles

MBS World Cup



All these products are also available for rental with the reference **PIARCD0 L**

WC27

with long Crossgrip | with short Crossgrip

WC30

with long Crossgrip | with short Crossgrip

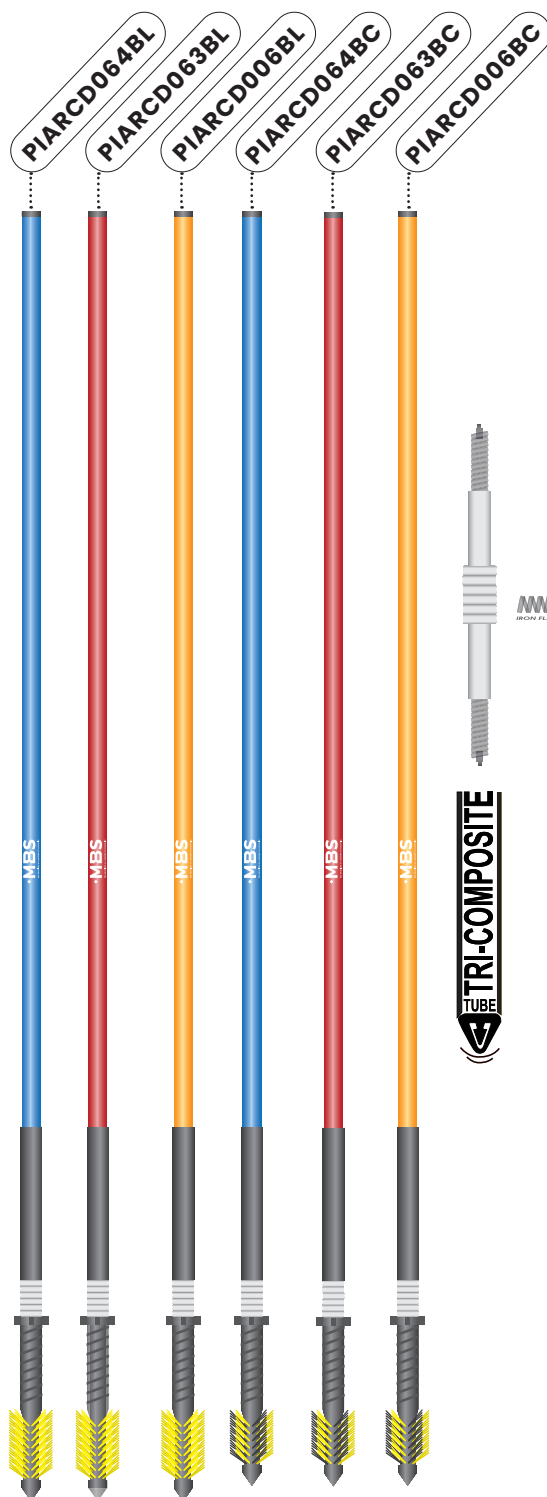
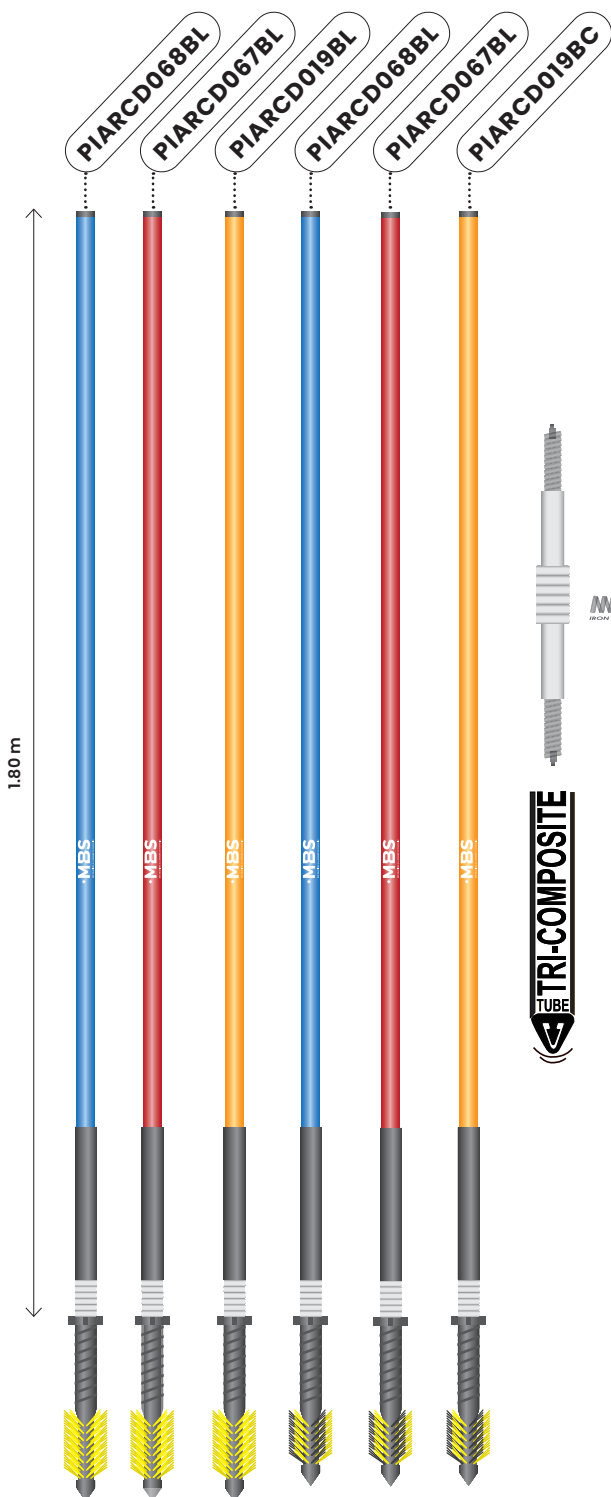

signage

safety

competition

leisure

facilities



competition

Poles

MBS Magic



Tri-composite tube. Long or short brush base. Polymer hinge. FIS homologated

Ø 27 mm

with long Crossgrip | with short Crossgrip

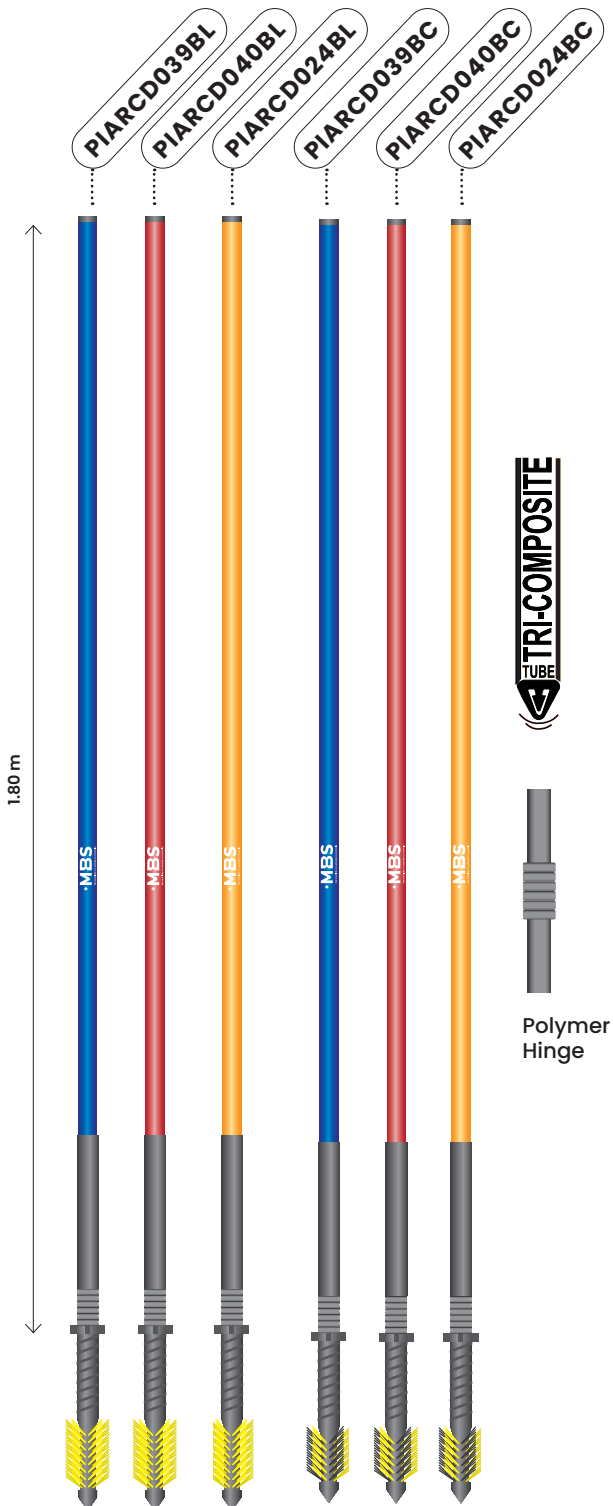

Ø 30 mm

with long Crossgrip | with short Crossgrip

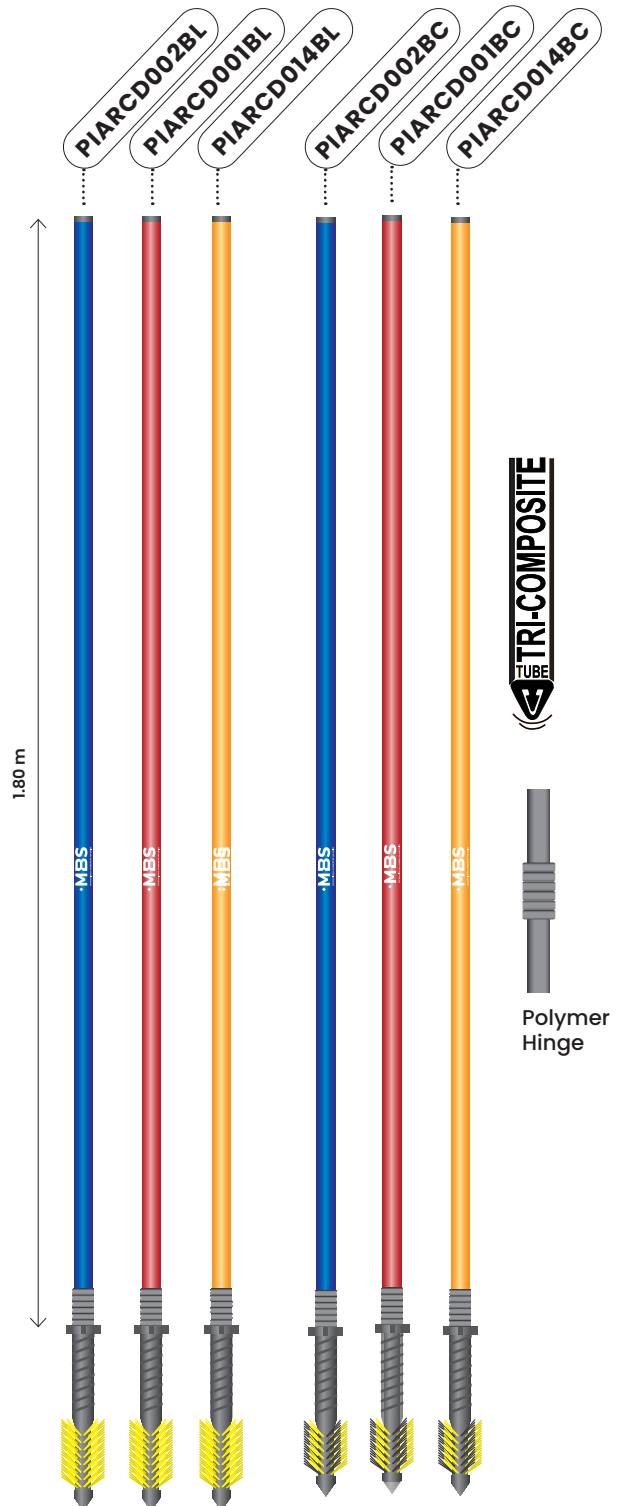



Poles

MBS Magic Ø 25

Hinged poles with Ø 25 mm tube. Height above snow 1.60 m

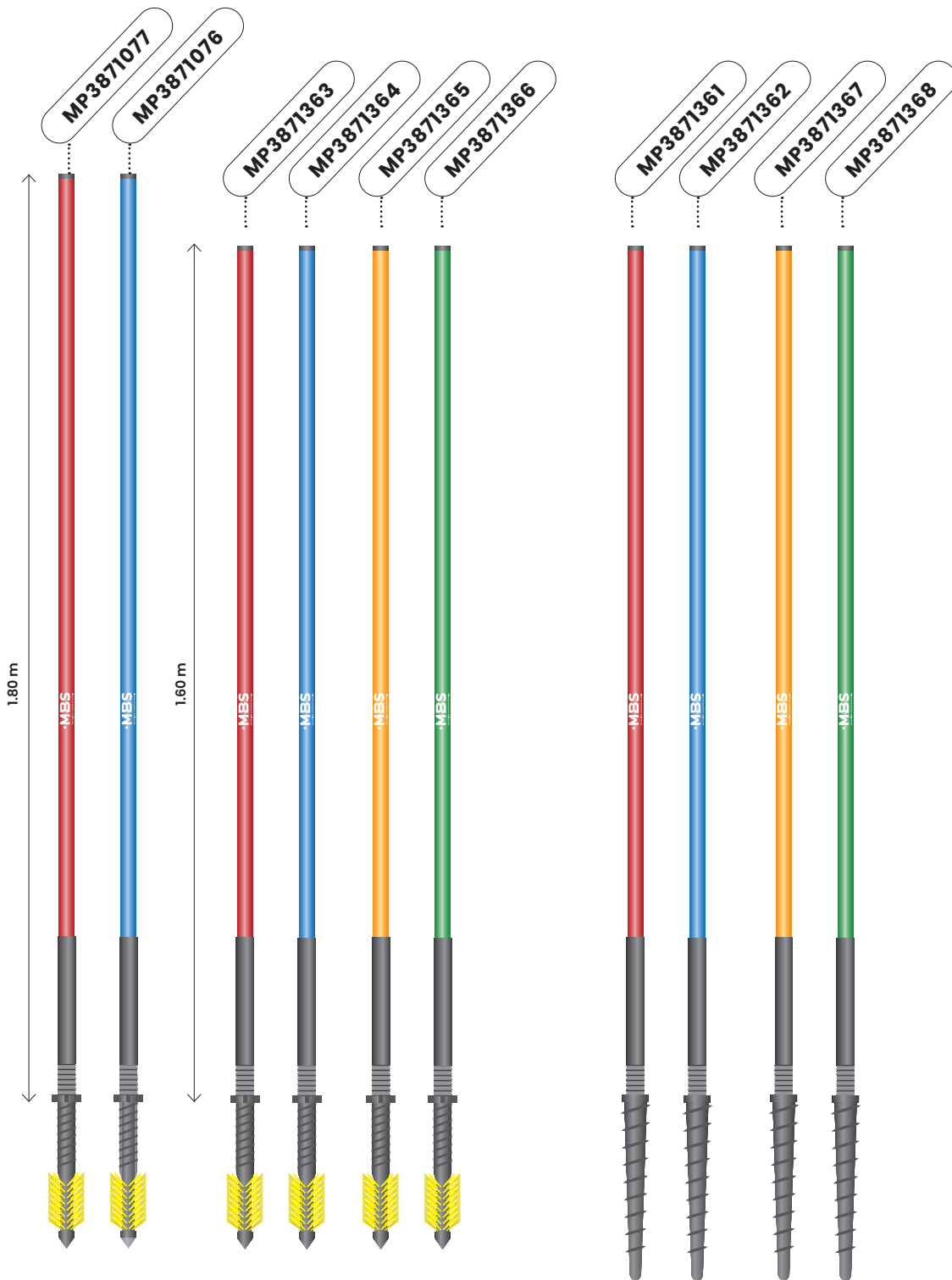

signage

safety

competition

leisure

facilities



Poles

MBS fixed with no hinges

Products listed in blue are available for rental.

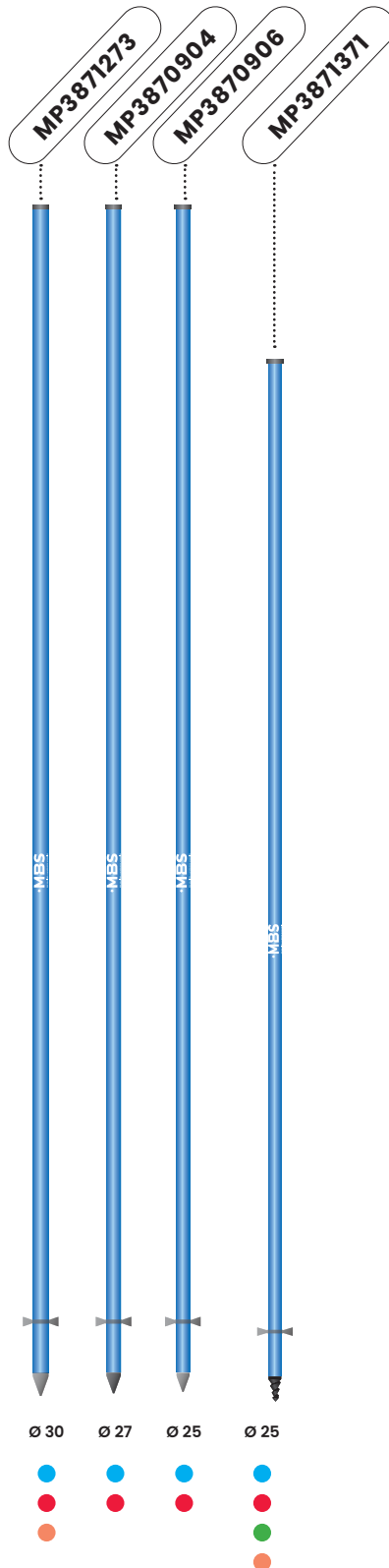

Ø 30 Conical point + anti-slip star 30x25x2150

Blue Red Orange



MP3871273

MP3871274

MP3871275

MP3871273L

Ø 27 Conical point + anti-slip star 27x22x2150

Blue Red



MP3870904

MP3870905

MP3870904L

MP3870905L

Ø 25 Conical point + anti-slip star 25x20x2150

Blue Red



MP3870906

MP3870907

Ø 25 Conical point + anti-slip star 25x20x1900

Blue Red Orange Green



MP3871371

MP3871370

MP3871372

MP3871373

Customize your MBS Poles



Customize the color of your poles for your event upon request*. Get in touch!



*With minimum order.





Poles

Training and accessories

Mini flexible

Ø 30 mm

Short crossgrip base

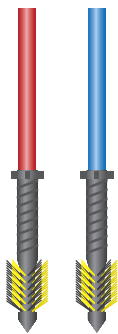
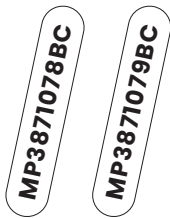

Maxi flexible

Ø 50 mm

Height above snow 80 cm

Hinge and screw base D 54 mm L 255 mm

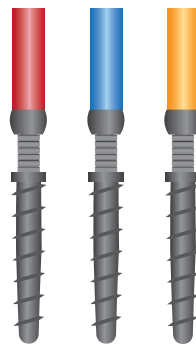
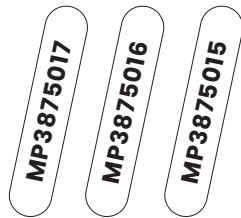

Short crossgrip base without hinge

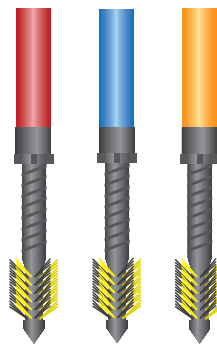
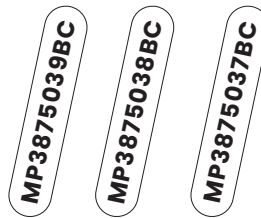

Maxi flexible

suitable for snowboard training Ø 50mm

height above snow 35 cm, polymer hinge with shell and long crossgrip base

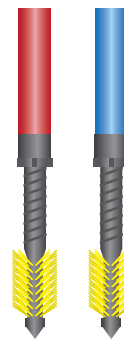
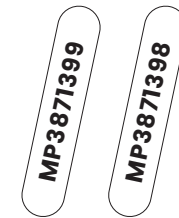

Brush poles

Strands made from HD Polyethylene

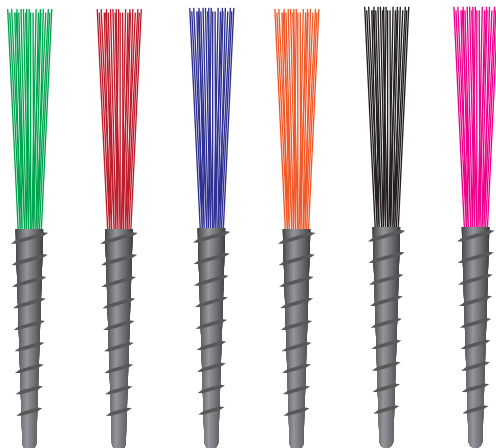
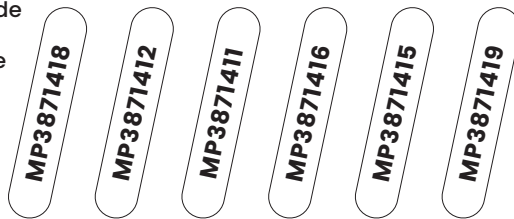

Bungee cord

with self-locking clip

For your bundles of poles L 700 mm Ø 8 mm

ACC101

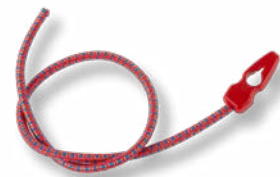

signage

safety

competition

leisure

facilities



Poles

MBS spare parts

These are all the spare parts for the poles presented above.

Ø
30 mm

Ø
27 mm

without tubing

without tubing

Ø 30 **PIAPCD003**

Ø 27 **PINAPY068**

Ø 30 **PIAPCD004**

Ø 27 **PINAPY069**

Ø 30 **PIAPCD008**

Ø 27 **PIAPCD013**



Polymer Hinge

with tubing

with tubing

Ø 30 **PIAPCD001**

Ø 27 **PINAPY064**

Ø 30 **PIAPCD002**

Ø 27 **PINAPY065**

Ø 30 **PIAPCD007**

Ø 27 **PIAPCD013**

tubing

tubing

FOQEMA08

FOQEMA06S

polymer Hinge

polymer Hinge

MP3871108

MP3871108



+



IFC Hinge

with tubing

with tubing

Ø 30 **PIAPCD033**

Ø 27 **PINAPY098**

Ø 30 **PIAPCD034**

Ø 27 **PINAPY097**

Ø 30 **COMING SOON**

Ø 27 **COMING SOON**

tubing

tubing

FOQEMA08

FOQEMA07

IFC Hinge

IFC Hinge

PIAPAR002

PIAPAR003



+



MP3871123

Anti-slip star MP
Ø30 mm - Red

MP38711272

Anti-slip star MP
Ø27 - Yellow for
d27 poles without
hinges





Ø
**25 mm
Magic 25**
without tubing

H 1.55 m

- Ø 25 ● **MP3871386**
- Ø 25 ● **MP3871385**
- Ø 25 ● **MP3871387**
- Ø 25 ● **MP3871388**



H 1.75 m

- Ø 25 ● **PINAKID001**
- Ø 25 ● **PINAKID002**
- Ø 25 ● **PINAKID006**
- Ø 25 ● **PINAKID005**



with tubing
for polymer hinge

H 1.75 m

- Ø 25 ● **MP3871128**
- Ø 25 ● **MP3871129**



Tubing

FOQEMA05



Polymer hinge

MP3871108



MP3871127

Anti-slip star MP Ø25
mm - Black



Bases

Can be used with any
diameter of pole

Conical base Ø

MP3871110

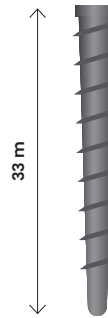

Short crossgrip base Ø35

PIAPPTBC

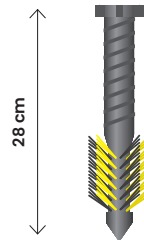

Long crossgrip base Ø35

PIAPPTBL

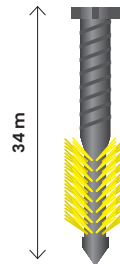

signage

safety

competition

leisure

facilities

Accessories



Tracing decameter
Automatic 20 m
unroller

FOQE00010



1L liquid coloring

RED
FOOUMN006

BLUE
FOOUMN007



25L liquid coloring

RED
FOOUMN053

BLUE
FOOUMN052



Pump sprayer

FOOUMN069



Radio support holder

SAC410

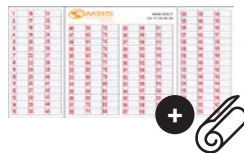

Results display
board
15 kg - Folding
(1 m x 1.20 folded)
+ sheet refill roll

DOAD00001

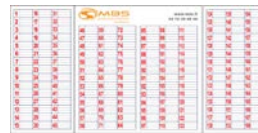

Board
+ Stand
+ Sheet roll Kit

250614



Stand
Racing bibs hanger

DOAD00002



100 m
plastic sheet
refill roll
for display board -
width 100 m x 100 cm

FOAD00002



Board
stand

FOAD00003



Racing bibs hanger

no. Ref.

1 > 50 **DOADPD003**

1 > 100 **DOADPD005**

1 > 150 **DOADPD006**

1 > 200 **DOADPD007**

1 > 250 **DOADPD001**

1 > 300 **DOADPD002**

1 > 400 **DOADPD004**

1 > 500 **DOADPD008**

V-boards

Suitable for furnishing your biathlon stages



254548

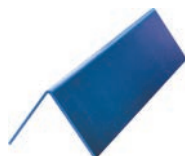

254549



Drills

Alu Speed

Aluminum snow drill
Other diameters upon request.
Delivery to be agreed when ordering

	SDS end	Smooth end
Ø 28	253861	253862
Ø 32	253440	253439
Ø 35	253442	253441
Ø 38	253868	253867
Ø 40	253863	253864
Ø 42	254841	254840
Ø 44	253865	253866



Set of 2 blades and screws for aluspeed

254297



Hand auger

FOOUMN056

while stocks last

Hole diameter	150 mm
Spiral length	up to 2060 cm
Length of travel	1140 cm
Weight	4.2 kg
Manufacturer	Mora, Finland



Carbide

Ø 35 mm

Ø 35 pink cobra snow drill smooth end

COM1863

Set of 2 carbide blades and screws

COM1864

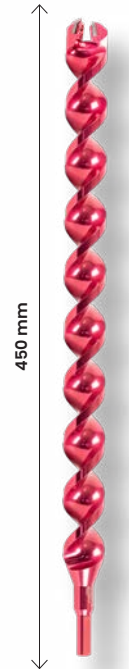

IDEAL FOR COMPETITION

signage

safety

competition

leisure

facilities

competition

Competition banners











Ski Cross

Openwork permeable fabric
Large sleeve with elastic at top, small sleeve with Velcro.



Maximum branding L 450 mm x H 350 mm







h x l mm	Not Customizable	Customizable 1 color Recto	Customizable 4 colors Recto	Customizable 1 color, Two-sided
1200 x 800	 BAPV00021	 BAPV00023	 BAPV00183	 BAPV00167
1200 x 800	 BAPV00022	 BAPV00024	 BAPV00184	 BAPV00168
1200 x 800	-	BAPV00027	254482	-

Snowboard

Openwork permeable fabric
Small closed sleeve with elastic at bottom.



Maximum branding L 450 mm x H 350 mm

h x l mm	Not Customizable	Customizable 1 color Recto	Customizable 4 colors Recto
1000 x 800	 BAPV00163	 BAPV00169	 BAPV00173
1000 x 800	 BAPV00164	 BAPV00170	 BAPV00174



World Cup

Openwork elastic fabric with Lycra sleeve.



Maximum branding
L 450 mm x H 350 mm

h x l mm	Not Customiz- able	Customizable 1 color Recto	Customizable 1 color Recto/ Verso
500x750	 BAPV00014	 BAPV00014R	 BAPV00014V
500x750	 BAPV00016	 BAPV00016R	 BAPV00016V
500x750	 BAPV00013	 BAPV00013R	 BAPV00013V

Non-homologated banners

Openwork fabric 500 mm x 400 mm
or 750 mm x 500 mm
with anti-slip elastic in the sleeves.

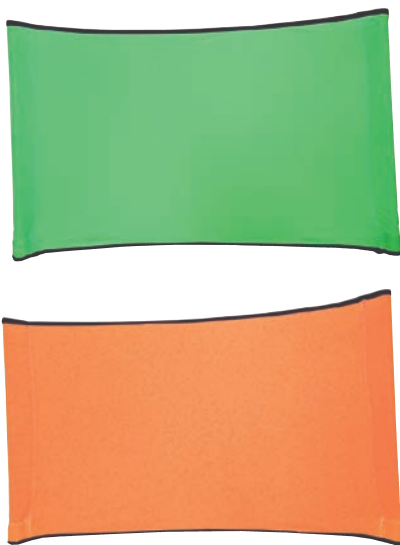

h x l mm	Not Customizable	Customizable 1 color Recto
500x400	 MP3871339	 MP3871339M
500x400	 MP3871341	 MP3871341M
500x400	 MP3871335	 MP3871335M
500x400	 MP3871336	 MP3871336M

h x l mm	Not Customizable	Customizable 1 color Recto
750x500	 BAPV00011	 BAPV00009
750x500	 BAPV00012	 BAPV00010
750x500	 MP3871337	 MP3871337M
750x500	 MP3871338	 MP3871338M
750x500		 BAPV00008



PROOFING explanations
and details on page 10

signage

safety

competition

leisure

facilities

competition

Racing bibs



Freeride racing bibs

Made of polyester mesh.
Sublimation printing.
For boardercross and snowboard competitions.



Adult 69x61 cm

DOPO00004A

Junior 62x51 cm

DOPO00004J

Child
57x48 cm

DOPO00004E

Snowboard racing bibs

Extendable polyester 2 waist elastics



Adult Boarder

DOPO00004A

Junior Boarder

DOPO00005J

Child Boarder

DOPO00005E

Racing bibs

Ideal for ski schools and nurseries

Made of polyester or mesh.
Sublimation printing.
Ideal for ski schools and nurseries.



Kid
extendable polyester
2 waist elastics

DOPO00007

Kid
Extendable polyester
1 waist elastic

DOPO00010

Lycra armband



255272

Ski Competition Racing bibs

Complies with FIS Alpine regulations for men or women.
Made of polyester mesh. Sublimation printing.
For Alpine ski competitions.



Two-way elastic

DOPO00002



Four-way elastic

DOPO00003

Nordic racing bibs

30x44

Made of non-woven fabric
Digital printing - Single use.



String

DOTN00001



PROOFING explanations
and details on page 10



Banners

Banners on poles

Banners made of high visibility openwork PVC mesh, L 2.00 m - H 0.50 m, installed with elastic loops on 2 fiberglass poles H 1.50 m.



BANI191



Vertical frame banners

Banner, W 0.80 m - H 1.50 m, mounted on a frame, W 0.80 m - H 2.00 m. Ø 30 mm poles. Corners assembled with clips.



Type	One-sided	Two-sided
Openwork mesh	BAPV00149	BAPV00149V
Digitally printed PVC canvas	BANI146	BANI146V



Banner made of PVC or fabric upon request

Horizontal frame banners

Banner L 2.00 m or 3.00 m - H 1 m, installed on framework L 2.00 m or 3.00 m - H 1.30 m. Ø 30 mm poles. Corners assembled with clips.



Type	L x H m	One-sided	Two-sided
Digitally printed PVC canvas	2x1	BAN270	BAN270V
	3x1	BANI147	BANI147V
Openwork mesh	2x1	BAPV00190	BAPV00190V
	3x1	BAPV00191	BAPV00191V



Finish line banners

Overhead finish line banners made from 350 gr/m² microperforated mesh (special dimensions upon request) 6 m x 0.60 m with nylon string and stiffeners.

BAPV00001



Contact us for any special requests. We would be only too happy to offer our support in organizing your events.

competition

Timekeeping

HC Timing



Premium Set

361286

Kit includes:
 1x wiNode Start gate
 1x wiTimer
 1x wiNode Photocell with reflector

Premium Plus Set

361288

Kit includes:
 1x wiNode Start gate
 1x wiTimer
 2x wiNode Photocell with reflector

Premium Speed Set

361287

Kit includes:
 1x wiNode Start gate
 1x wiTimer
 3x wiNode Photocell with reflector



+ in every set

The wifi interface means results can be checked in real-time using a smartphone. Mesh network technology with automated, self-perpetuating modulation.

Included in every set
 100 devices (web, smartphone, etc.) can connect at the same time to check results. Option to configure 7 administrators

1x carry backpack

License subscription free for the first year

Get in touch with us for additional options

<p>wiNode Start gate</p> 	 	<p>Backpack</p> 
<p>wiNode Photocell with reflector</p> 		 <p>wiTimer</p> 

GENERALI

LIQUI MOLY

LIQUI MOLY

LIQUI MOLY

LIQUI MOLY

GENERALI

LIQUI MOLY

LIQUI MOLY

HARGASSNER
Val d'Isère

HARGASSNER
Val d'Isère

HARGASSNER
Val d'Isère



competition

Timekeeping Simple

ALGE
 TIMING

Basic timekeeping system, consisting of a timekeeping device, a start gate, and a photo-cell. It can be extended as needed. We also recommend headsets for voice connection between the race starter and the timekeeper, a start clock such as the Startclock ASC3, and a display board.

Do you have more specific needs?
 Get in touch with us to find out more.
 We can also advise you on cabling
 solutions and spare parts.

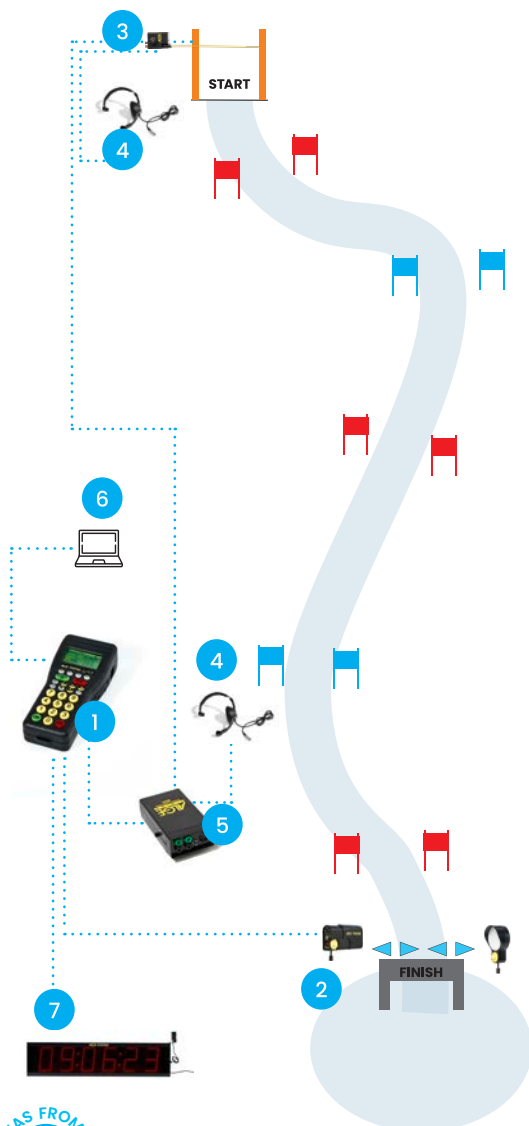

GREAT IDEAS FROM MIB

Backpack ATPB
ATPB

Ideal for carrying your ALGE TIMING timekeeping equipment

TIMY3WP

Option with case:

TIMY3WP-S
1 Timy3 WP

High-end FIS-homologated timekeeping device for timekeeping professionals with a large, easy-to-read graphic screen, up to 8 timekeeping channels, and a log printer. USB and RS232 interfaces are built into the device for data transfer. A built-in WTN radio module enables wireless communication with other devices.

PR1A
PR1A-REF
2 PR1a photocell and PR1a-REF reflector

Photocell with transmitter/receiver unit without built-in WTN radio. The system is composed of a photocell, a reflector, and chain brackets. The photocell can cover distances up to 25 m.

STSNM2S
3 Start gate STSnM2S

Single contact, double contacts with amp (FIS homologated). Manual wand reset.



one-sided headset

HS4-1

double-sided

**headset
 HS4-2**
4 Connection headset HS4-1 and HS4-2

One option is to have a two-channel voice connection at the start line. In this way, the timekeeper can speak with the race starter. Different voice amplifiers and headsets are available.

SV4-S
5 Voice amplifiers SV4-S

Multi-function voice amplifier to connect at the start-finish line and link up with the headset connection.

TIME.NET2
6 Results software Time.NET2

Universal results software (freeware) from ALGE-TIMING, ideal for short ski races.

D-LINE
7 Display board D-LINE

digital display board with 7-segment red diodes for indicating the time, race bib, and level (e.g. D-LINE250-O-6-E0)

Additional option: LED Matrix board D-RTNM upon request.



competition

Timekeeping with TED radio

ALGE
TIMING

The TED2 radio system is renowned for its reliability and performance on Alpine terrain. It can manage up to eight intermediate times. TED2 is also homologated for FIS races.

Do you have more specific needs?
Get in touch with us to find out more.
We can also advise you on cabling solutions and spare parts.

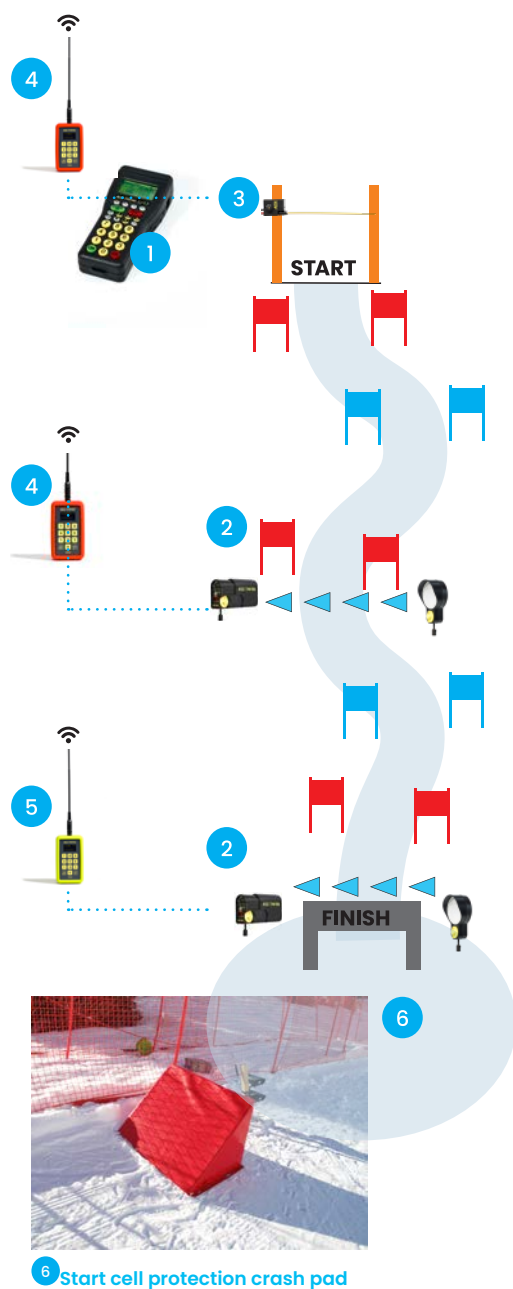

6 Start cell protection crash pad

MASTAF030

Triangular foam protection crash pad for cell with 2 braids for polycarbonate pole with 48 mm diameter, not included



1 TIMY3 WP

High-end FIS-homologated timekeeping device for timekeeping professionals with a large, easy-to-read graphic screen, up to 8 timekeeping channels, and a log printer. USB and RS232 interfaces are built into the device for data transfer. A built-in WTN radio module enables wireless communication with other devices.

TIMY3WP

Option with case:

TIMY3WP-S

PR1A
PR1A-REF

2 PR1a photocell and PR1a-REF reflector

Photocell with transmitter/receiver unit without built-in WTN radio. The system is composed of a photocell, a reflector, and chain brackets. The photocell can cover distances up to 25 m.

STSNM2S

3 Start gate STSnM2S

Single contact, double contacts with amp (FIS homologated). Manual wand reset.



Long-range transmitter for radio system

TED2-TX

4 Radio transmitter/receiver

Long-range transmitter for radio system.



Long-range receiver for radio system

TED2-RX

5 Radio transmitter/receiver

Long-range receiver for radio system



Timekeeping for competitions

This timekeeping system is recommended for official competitions such as FIS races



Do you have more specific needs? Get in touch with us to find out more. We can also advise you on cabling solutions and spare parts.

Do you need help organizing your sporting event? Get in touch with us



option for parallel or cross start upon request with SSD1 gate

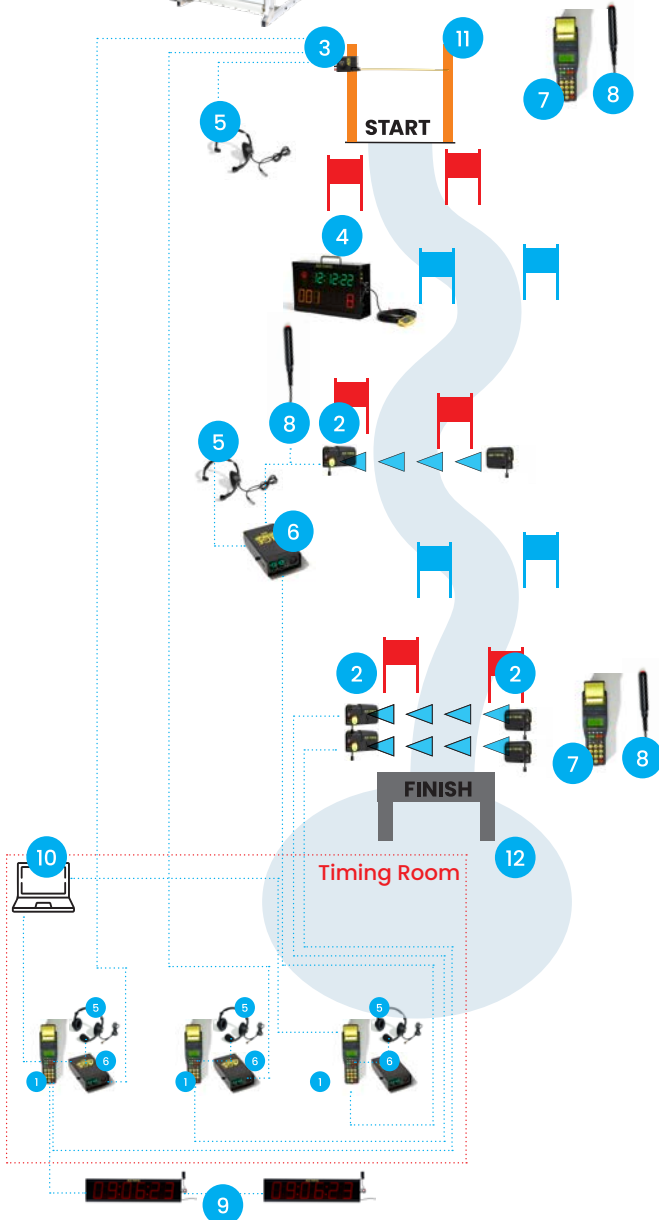

- 

1 **Timy3 WP**
TIMY3WP
- 

2 **PR1a photocell**
PR1A
- 

3 **Start gate STSnM2S**
STSNM2S
- 

4 **Start clock ASC3**
ASC3

Digital start clock which uses the latest LED technology. Universal battery-powered operation, precise information, and optimal for daytime and nighttime use.
- 

5 **Connection headset HS4-1 and HS4-2**
HS4-1
HS4-2

One option is to have a two-channel voice connection at the start line. In this way, the timekeeper can speak with the race starter. Different voice amplifiers and headsets are available.
- 

6 **Voice amplifiers SV4-S**
SV4-S

Multi-function voice amplifier to connect at the start-finish line and link up with the headset connection.
- 

7 **Timy3 WP (Manual Timing)**
TIMY3WP
- 

8 **Push Button 023-02**
MBS023-02
- 

9 **Display Board D-LINE**
D-LINE
- 

10 **Results software Time.NET2**
TIME.NET2
- 

11 **Start Poles**
- 

12 **Start cell protection crash pad**
MASTAF030

Timekeeping

with the WTN system for ski schools

ALGE
TIMING

The Wireless Timing Network WTN is quick to set up for short-distance races. It establishes a radio link between all devices and is ideal for ski schools.

Do you have more specific needs?
 Get in touch with us to find out more.
 We can also advise you on cabling
 solutions and spare parts.

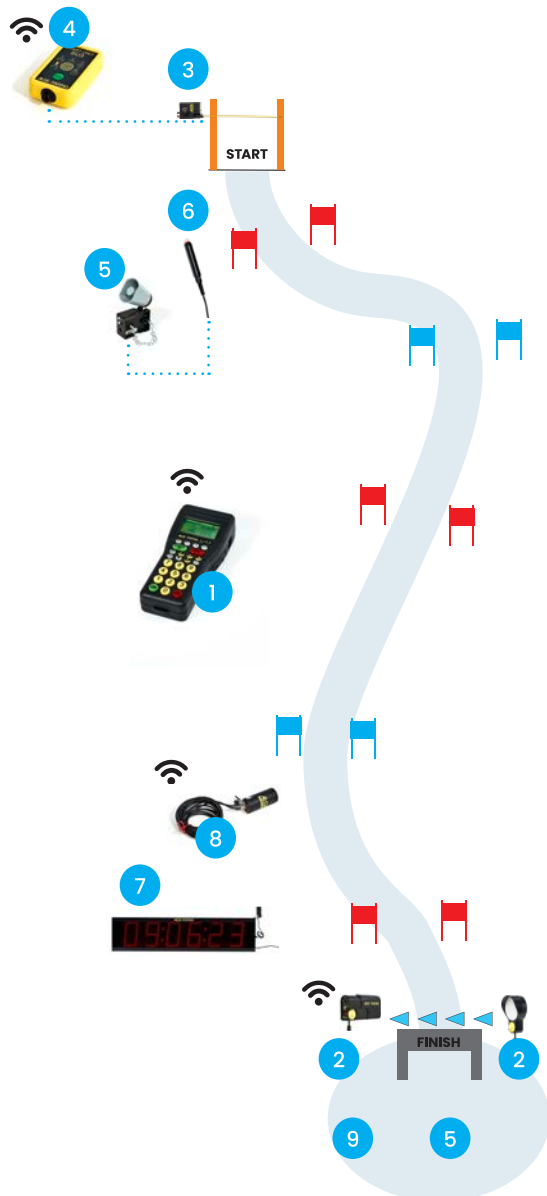

1 Timy3 WP

High-end FIS-homologated timekeeping device for timekeeping professionals with a large, easy-to-read graphic screen, up to 8 timekeeping channels, and a log printer. USB and RS232 interfaces are built into the device for data transfer. A built-in WTN radio module enables wireless communication with other devices.



TIMY3WP
 Option with case.

TIMY3WP-S

2 PR1a photocell and PR1a-REF reflector

Photocell with transmitter/receiver unit and built-in WTN radio. The system is composed of a photocell, a reflector, and chain brackets. The photocell can cover distances up to 25 m.



PR1A

PR1A-REF

3 Start gate STSnA1

Start wand with automatic reset. Forward motion starts the timekeeping device.



STSnA1

4 The Wireless Timing Network WTN

The wireless timing network WTN is used to transmit the starting motion.



WTN

5 Startbeep STB1

Audible countdown



STB1

6 Push button

For starting the STB1 countdown; strong, water-resistant push button for manual timekeeping with a cable that is 2 m in length to connect it to the timekeeping device



MBS023-02

7 Display board D-LINE

digital display board with 7-segment red diodes for indicating the time, race bib, and level (e.g. D-LINE250-O-6-E0)

Additional option: LED Matrix board D-RTNM upon request.



D-LINE

8 Radio receiver for display board WTN-DB

for receiving data for the timekeeping device's display board.



WTN-DB

9 Start cell protection crash pad:

Triangular foam protection crash pad for cell with 2 braids for polycarbonate pole with 48 mm diameter, not included



MASTAF030



competition

leisure

facilities

Leisure

◆ MBS: BEST-FIT SOLUTIONS FOR YOUR EVERY NEED



148

Signature projects	P. 150
Zip-line	P. 154
MTB activities	P. 156
On foot	P. 160
Toboggan	P. 178
Ski activities	P. 186





Signature projects



Our "Summit Fun" park offers a full range of activities and a variety of attractions in the different recreation areas which have been specifically designed to meet the needs of families and our customers.

A big Speedline zip-line!

Check out the zip-line activities on page 154



3 toboggan activities:

tubing, alpine slide, fun coaster!
SEE page 178



Lots to do on foot:

Kidpark, Picnic, Roll my ball, etc.
SEE page 160



SUMMER VERSION 

With our expertise, we can ensure comprehensive management of each stage, from design to on-site installation, all year round: winter, summer, or an all-weather experience.

As genuine experts in recreational projects, we stand out from the competition as a result of our unique know-how, and our ability to design fully customized parks. This makes us your essential partner for unforgettable experiences.

An MTB park
Check out the MTB activities on page 156



2024 Judo



Signature projects



Our "Summit Fun" park offers a full range of activities and a variety of attractions in the different recreation areas which have been specifically designed to meet the needs of families and our customers.

Zip-line -
even open
in winter!



The Alpine slide -
replaced with
a toboggan run!
Tubing and
Funcoaster are
still open



**The activities
you can do
on foot are
accessible in summer
and winter**

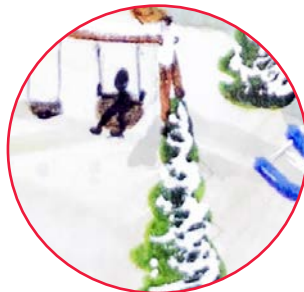



WINTER VERSION

Our services:

- Providing strategic analysis, considering diversification
- Bringing together the best experts and specialists in a ready-to-use plan with a 360° approach and customized project management
- Creating a comprehensive plan to stand out from the competition
- Present the client with a customized, appealing product
- Implementing activities which are suitable for the location to provide unforgettable experiences.

A Funrun: a recreational ski area. You can also check out our skiing activities on [page 186](#)



leisure

Zip-line

A comprehensive, integrated range

An extraordinary aerial adventure

- Can be up to 2500 m in length with a 33% gradient.
- Descends at 100 km/h or more.
- Lines run parallel to enable the experience to be shared safely.
- A favorite activity for families and novices.
- Are you ready for the most exciting descent of your life?



Spectacular and accessible, aerial experiences are a real advantage, enabling you to fly over a location without having a negative impact on the ecosystem, for a guaranteed adrenaline rush!

Operational advantages

SAFETY

the safest range on the market

Technology adapted to suit your plan and your location.

Technology combined with safety, using pulleys for braking on the line and/or at the end of the run.

CUSTOMIZATION

Customer experience

We can adapt our start or end platforms, signage, the number of lines, and the position on the line to suit each recipient.

But we can also create a unique, identifiable, specific world to enhance your customers' journey.



Presentation video

Option for extreme implementation

- Our integrated design office provides you with ready-to-use plans (analysis, calculation, process, etc.) which make the most of the "natural" requirements of your location
- Option to fly over various obstacles (river, lake, rise), ending on the ground or at height.

Zip-line



MODEL	FUN LINE
Length	100 to 1500 m
Gradient	6 to 15%
Speed	Up to 100 km/h (depending on the profile of the line)
Accessibility	For people weighing 20 to 150 kg
Safety	Optimized safety with an automatic braking system for the end of the run - ZIP STOP®
Special features	<ul style="list-style-type: none"> • Anchored on artificial structure • Different start and finish platforms
Options	<ul style="list-style-type: none"> • Photobox • Possibility of including a theme
Staff	2 operators
Time frame for delivery	3 - 8 months

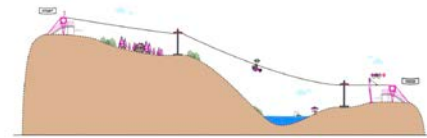
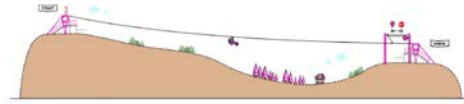

MODEL	SPEEDLINE	ADRENALINE
Length	500 to 2500 m	Up to 2500 m
Gradient	12 to 33%	15 to 30%
Speed	Up to 120 km/h (depending on the profile of the line)	Up to 120 km/h (depending on the profile of the line)
Accessibility	For people weighing 20 to 130 kg	For people weighing 20 to 130 kg
Safety	<ul style="list-style-type: none"> • Braked pulley for speed regulation • Braking system at the end of the line • Option: anti-collision system 	<ul style="list-style-type: none"> • Braked pulley for speed regulation • Braking system at the end of the line • Option: anti-collision system
Special features	<ul style="list-style-type: none"> • Head first (depending on configuration) • Solo or duo up to 130 kg per pulley • Anchored on artificial structure 	<ul style="list-style-type: none"> • Makes the most of "natural" options at the location with one or more intermediate pylons • Solo or duo up to 130 kg per pulley • Anchored on artificial structure
Options	<ul style="list-style-type: none"> • Photobox • Possibility of including a theme • Configuration stages in a multi-activity route 	<ul style="list-style-type: none"> • Photobox • Possibility of including a theme • Configuration stages in a multi-activity route
Staff	2 to 3 operators	2 to 3 operators
Time frame for delivery	6 - 8 months	6 - 8 months

signage

safety

competition

leisure

facilities



leisure

MTB

MTB activities

Your custom MTB modules

Bring all your ideas to life with our customizable solutions which will meet your needs.



Customize your MTB signage



PROOFING
explanations
and details
on page 10

We custom produce all the necessary signage for your MTB trails. Get in touch!



Check out all the standard MTB signage on page 27





Agility modules

Acacia wood structure
Treatment for the raw wood surface (option: oil or paint)

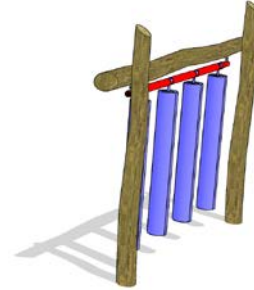

MTB stand bench

Steel and wood structure
Dimensions: H 0.70 m / 2.20 m
Weight 90 kg
Treatment for the raw wood surface (option: oil or paint)
Steel surface treatment: paint
Fastening to the ground: plate for anchoring in the ground

VTT018



Advantages

Mountain bike stand bench

- 1 Good useful life
- 2 Standard furniture
- 3 Environmentally-responsible materials

Cattle grid

Steel structure
Dimensions: 1.8 x 1 m, height 30 cm
Weight 33 kg
Galvanized surface treatment
Stackable for storage

VTT006



Advantages

Cattle grid

- 1 Easy to move
- 2 Good useful life
- 3 Standard furniture
- 4 Easy to store

⊕
The MBS + : thread your fence wires through the cattle grid directly

signage

safety

competition

leisure

facilities

leisure

MTB modules



Larch wood structure
 Untreated wood, option to oil or paint it.
 Covering: boards
 It is possible to add plates to attach the modules to a concrete foundation



Advantages
Mountain biking modules

- 1 Easy to move
- 2 Good useful life
- 3 Easy to store
- 4 Environmentally-responsible materials
- 6 Standard furniture



Ascent Descent

Dimensions H x D x L	Ref.
Wide 0.33 x 1 x 3.60	VTT007
Balance 0.33 x 0.5 x 3.60	VTT008



Vibrating Ascent Descent

Dimensions H x D x L	Ref.
0.33 x 1 x 3.60	VTT009



Ascent Flat Descent

Dimensions H x D x L	Ref.
Wide 0.33 x 1 x 4.60	VTT001
Balance 0.33 x 0.5 x 4.60	VTT011



Balance beam

Dimensions H x D x L	Ref.
0.33 x 0.5 x 4.00	VTT010



V balance beam

Dimensions H x D x L	Ref.
0.33 x 0.5 x 4.00	VTT019



Vibrating

Dimensions H x D x L	Ref.
Wide 0.12 x 0.90 x 4.00	VTT012
Balance 0.12 x 0.45 x 4.00	VTT013

MTB modules



Teeter totter
Larch wood structure, steel plate

Dimensions H x D x L	Ref.
0.25 x 0.45 x 3.00	VTT002



Kiker

Dimensions H x D x L	Ref.
0.26 x 1 x 1.30	VTT003



Double Whoops

Dimensions H x D x L	Ref.
0.26 x 1 x 3.90	VTT004



Step

Dimensions H x D x L	Ref.
0.33 x 1 x 4.30	VTT005



Whoops

Dimensions H x D x L	Ref.
0.48 x 1 x 3.90	VTT014

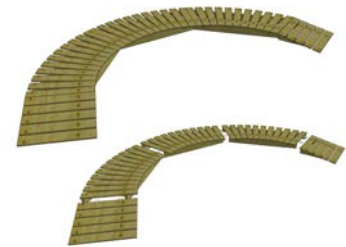

Flat turn
Modular turn with
3 different shapes of structure
to assemble

Dimensions H x D x L	Ref.
Ascent (1st or final turn module) 0.18 x 1 x 2.20	VTT015
Flat (intermediate modules) 0.18 x 1 x 2.20	VTT016



Banked turn
Modular turn with one shape of structure
to assemble

Dimensions H x D x L	Ref.
0.55 x 1 x 1.40 per module	VTT017



Repair your modules

Every board can be replaced.
These parts can be manufactured in the workshop and
installed at the location. Adjustments will need to be made
on site.

signage

safety

competition

leisure

facilities



On foot

Activities you can do on foot



The Picnic range

Ski resorts have been asking us to develop recreational and picnic equipment which is suitable for extreme mountain conditions.

We had to choose materials which are suitable for this environment, such as larch and steel.

In order to ensure that these spaces are easy to maintain, this material needs to be easy to move for removing snow.

Therefore, we needed to find solutions to make the structures lighter, but still as strong as possible. We have also added anchoring and lifting systems. For example, our huts are fixed to a steel chassis with runners and lifting attachments. We also produce photo points which make the most of your Picnic areas, upon request.



©MBS

crédit photo



MBS: BEST-FIT SOLUTIONS FOR YOUR EVERY NEED



An experienced
technical team,
at your service

Some clients also want to customize their furniture with their image. Therefore, we have chosen to adapt one part of the structure of each piece of furniture to enable it to be customizable.





leisure

Activities you can do on foot

Picnic range

Table

PICNIC001

Wood and steel structure

Dimensions:

H 0.80 m / 1.70 m / 2 m

Wooden runner to make it easier to move

Custom shapes and colors

Treatment for the raw wood surface

(option: oil or paint)

Corten steel (stabilized natural rust, does not stain),

additional option for paint,

choice of RAL



High strength table, still a suitable weight for moving



Advantages

Table

- 1 Easy to move
- 2 High wind resistance
- 3 Good useful life
- 4 Environmentally-responsible materials
- 5 Standard furniture

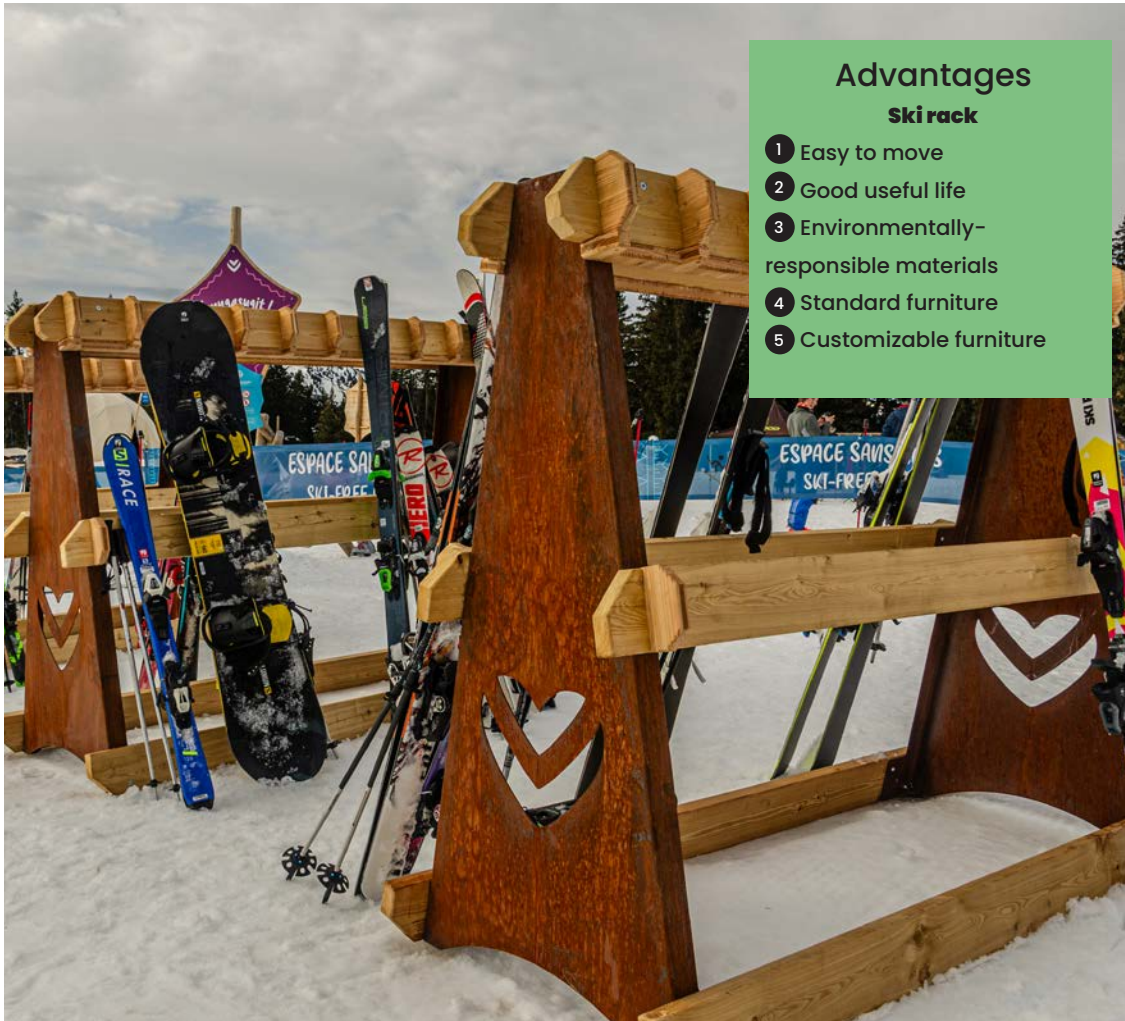

Advantages

Ski rack

- 1 Easy to move
- 2 Good useful life
- 3 Environmentally-responsible materials
- 4 Standard furniture
- 5 Customizable furniture

signage

safety

competition

Ski rack

PICNIC002

Wood and steel structure
 Dimensions: H 1.70 m / 2 m
 Customizable decoration and color
 Wooden runner to make it easier to move
 Treatment for the raw wood surface
 (option: oil or paint)
 Corten steel (stabilized natural rust, does not stain), additional option for paint, choice of RAL

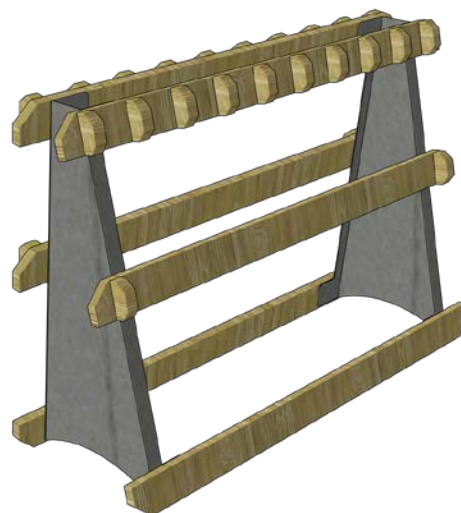

leisure

facilities



On foot

leisure

Hammock

PICNIC003

Wood structure
 Dimensions: H 4 m / 3 m
 Customizable flag
 Height-adjustable net
 Surface treatment: untreated, option for oil or paint
 Attachment to concrete foundation



Advantages

Hammock

- 1 High wind resistance
- 2 Good useful life
- 3 Environmentally-responsible materials
- 4 Standard furniture
- 5 Customizable furniture



Chair

PICNIC004

Steel and wood structure
 Wooden runner to make it easier to move
 Hook for hanging a bag
 Dimensions: H 0.70 m / 1.70 m / 0.70 m
 Custom shapes and colors
 Customizable color
 Wood surface treatment: untreated, option for oil
 Steel surface treatment: paint, option for rust
 Standard colors Red / Orange / Green / Blue / White / Brown

Advantages

Chair

- 1 Easy to move
- 2 High wind resistance
- 3 Good useful life
- 4 Easy to store
- 5 Environmentally-responsible materials
- 6 Standard furniture
- 7 Customizable furniture





Sofa

PICNIC005

Wooden structure, seat made of foam and tarpaulin

Wooden runner to make it easier to move

Dimensions: H 0.82 m / 1.60 m / 0.95 m

Customizable printing

Surface treatment: untreated, option for oil or paint

Option for extension



Advantages

Sofa

- 1 Easy to move
- 2 High wind resistance
- 3 Good useful life
- 4 Environmentally-responsible materials
- 5 Standard furniture
- 6 Customizable furniture

Picnic Hut

Wood structure

Sofa made of foam and tarpaulin

Steel runner for moving the hut with a motor

Custom shapes and colors

Dimensions: H 2.50 m / 2 m / 2 m

Surface treatment: untreated, option for oil or paint



We have developed this hut to provide ski resorts with a piece of recreational furniture which does not require snow removal.

For holidaymakers, this piece of furniture allows them to rest for a moment and shelter from the wind.

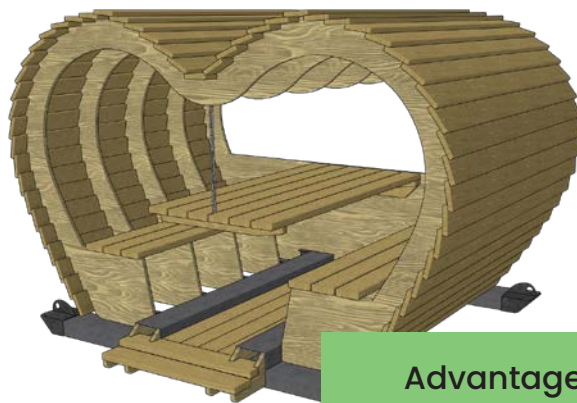

Advantages

Picnic Hut

- 1 Easy to move
- 2 High wind resistance
- 3 Good useful life
- 4 Environmentally-responsible materials
- 5 Customizable furniture



on foot



The Roll my ball range

A wooden adventure for the whole family!

Discover the magical story of our little wooden ball! It rolls, it climbs, it falls, it bounces, it hides... and it even rings the bell! A fun companion which provides endless enjoyment for both young and old.

A unique, natural concept: Our wooden ball runs invite you to play on different modules, such as walls and tables, for an original game adventure.



Runs can be adapted to any space:

- Suitable for natural terrain
- Along a path or in a dedicated area
- To complement other leisure activities
- Supported on a mechanical riser
- Indoors or outdoors
- In the middle of nature, in the woods, or along a path
- Unique animation
- Anything is possible when you install Roll my Ball as an activity at your location!



Why choose Roll my Ball?

- Environmentally-friendly and integrated: Our wooden modules are environmentally-friendly and blend into the landscape.
- Customizable: Adapt the modules to suit each destination with specific themes and logos.
- Intergenerational: An activity which will enchant children of all ages, their parents, and grandparents.
- Revenue streams: Profit from the sale of balls and associated activities.
- Autonomous: A ball distributor (optional) enables fully autonomous operation.

**Ready to make each day
an adventure?**

*Roll my Ball is waiting for you, for fun times
and endless discovery!*



leisure

On foot

Roll my Ball



Modules to join together however you choose!

- Single or double channel
- Tables: wheel, balance, slalom, jump, cross, maze, flipper, etc.
- Walls: jump, lift, etc.
- Question boxes, cable cars, caravans, etc.
- 3 installation options: mobile, detachable, fixed
- Larch or douglas wood structures
- Surface treatment: untreated, option for oil or paint



Tables

Wheel table





Walls

Lift wall



Maze wall



Other (even more insane) models

Cable car

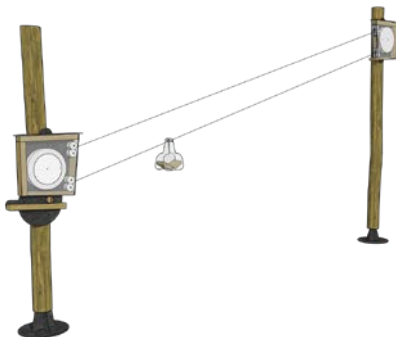

Caravan



Other models available

Get in touch, and we will work with you to build the most insane Roll my Ball which will impress your customers and enchant their children!

signage

safety

competition

leisure

facilities





leisure

On foot

The Kidpark range

Slide

Foam and polymer structure

Anchoring to be buried under snow.

Each slide includes 2 PE anchors.

Dimensions: 3 m / 0.75 m

3 m section to be assembled, creating all the toboggan shapes

Three shapes: straight / left turn / right turn

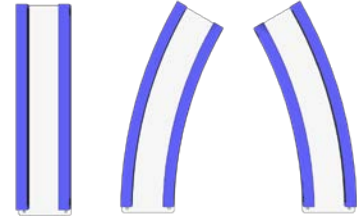

Fastening strip

KID005

PE anchoring

KID001

Straight

KID002

Left turn

KID003

Right turn

KID004



These slides can be assembled to create any shape. Their flexibility enables them to adapt to any terrain.

Advantages slide

- 1 Easy to move
- 2 High wind resistance
- 3 Good useful life
- 4 Easy to store
- 5 Safety (play area standard)
- 6 Standard furniture



The Kidpark range



Tinygloo

Polymer structure
One or two doors
Option to join together several Tinygloos
Delivered as a kit to be assembled



1 entrance Tinygloo

369660



2 straight entrances Tinygloo

369661

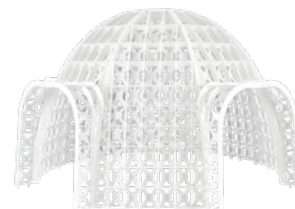

2 curved entrances Tinygloo

369769

Advantages

Tinygloo

- 1 Easy to move
- 2 High wind resistance
- 3 Good useful life
- 4 Easy to store
- 5 Standard furniture



Cave

PE tube and wood structure
Dimensions: H 3.50 m / 4 m
with 2 openings /
1 m diameter tube

Dimensions: H 3.50 m / 2 m with 1 opening /
1 m diameter tube
PE tube to be buried under snow or ground
Option for sound effect
and internal games
Surface treatment: untreated,
option for oil or paint.

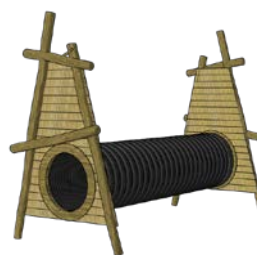

KID010



KID009



These caves enable indoor games to be provided. This makes it easier to utilize a snowy area.

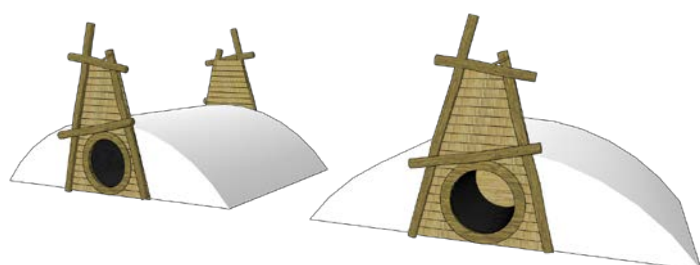

Advantages

Cave

- 1 High wind resistance
- 2 Good useful life
- 3 Safety (play area standard)
- 4 Standard furniture



On foot

leisure

Zip-line

KID008

Wood structure

Dimensions: H 4 m / 20 m / 4 m

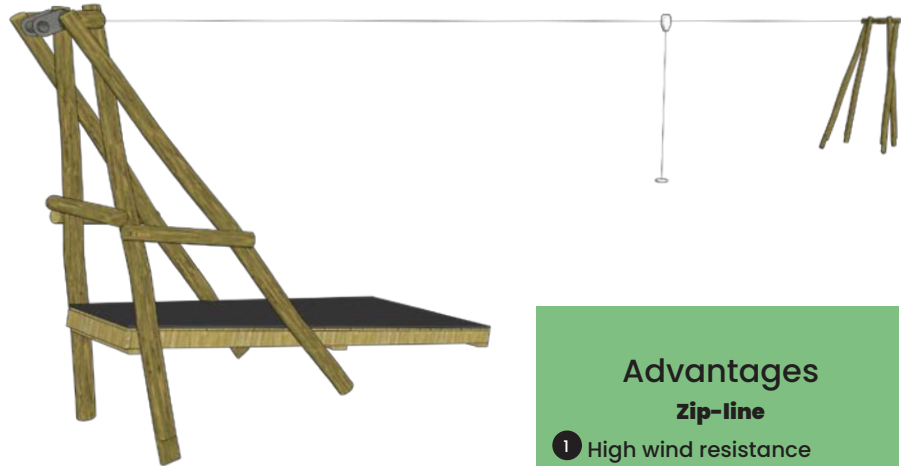
Surface treatment: untreated,
option for oil or paint.

Advantages

Zip-line

- 1 High wind resistance
- 2 Good useful life
- 3 Safety (play area standard)
- 4 Environmentally-responsible materials
- 5 Standard furniture





Advantages Swing

- 1 Easy to move
- 2 High wind resistance
- 3 Good useful life
- 4 Safety (play area standard)
- 5 Environmentally-responsible materials
- 6 Standard furniture

Swing

KID006

Wood structure
Can be disassembled into 3 parts
to make it easy to move and transport
Dimensions: H 2 m / 4 m
Surface treatment: untreated,
option for oil or paint



*This swing is self-supporting, no anchoring required.
This enables it to be used on the snow.*



signage

safety

competition

leisure

facilities



leisure

On foot

Jump crash pad

KID011

Foam and tarpaulin structure
Hydrophobic foam to prevent ice from forming in the structure
Dimensions: 2 m / 2 m / 0.32 m

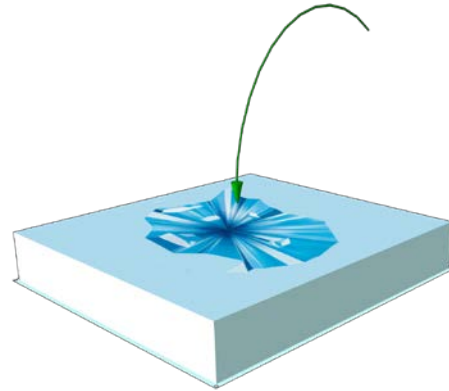

Advantages

Jump crash pad

- 1 Easy to move
- 2 High wind resistance
- 3 Good useful life
- 4 Easy to store
- 5 Safety
- 6 Standard furniture
- 7 Customizable furniture

Curling

KID007

Transparent PC panel and wood discs
Place the panels flat on the snow so that they overlap
Dimensions of each panel: 2 m x 1.30 m



Advantages

Curling

- 1 Easy to move
- 2 High wind resistance
- 3 Good useful life
- 4 Easy to store
- 5 Safety
- 6 Standard furniture

The Kidpark range



Snowball throwing

KID013

Wood structure, steel bell
Pole to hammer into the snow
+ steel plate
Dimensions: H 2.50 m / 1 m
Surface treatment: untreated, option for oil or paint.



Advantages

Snowball throwing

- 1 High wind resistance
- 2 Good useful life
- 3 Safety
- 4 Environmentally-responsible materials
- 5 Customizable furniture

Construction Games

KID014

Foam and tarpaulin structure
Dimensions: 0.30 m side
Customizable printing



Advantages

Construction games

- 1 Easy to move
- 2 Good useful life
- 3 Easy to store
- 4 Safety
- 5 Customizable furniture



signage

safety

competition

leisure

facilities



On foot

leisure

Fishing games

KID015

Wood structure
 Water in printed tarpaulin
 Rings and hooks for catching fish
 Dimensions: 1.60 m / 1.60 m / 0.60 m
 Surface treatment: untreated, option for oil or paint
 Weight 90 kg



Advantages

Fishing games

- 1 Easy to move
- 2 High wind resistance
- 4 Easy to store
- 5 Safety
- 6 Customizable furniture



Elf Hut

KID016

Wood structure
 Different options for games inside (maze, ball run, puzzle, etc.)
 Steel runner for moving the hut with a motor
 Dimensions: H 3.20 m / 2 m / 2 m
 Surface treatment: untreated, option for oil or paint.



This hut is on a steel chassis, and can be lifted or towed.

This makes it easier to utilize a snowy area.



Advantages

Elf Hut

- 1 High wind resistance
- 2 Good useful life
- 3 Safety
- 4 Environmentally-responsible materials
- 5 Standard furniture
- 6 Customizable furniture



The fitness range

A comprehensive, integrated range

Check out our fitness range to complete the furnishing of your recreation location, and provide an enriching, diverse experience for your visitors.



These courses are suitable for all weather conditions, highlighting the snowy scene, or any other space, by offering your customers a supplementary activity for sports training.

Our products are homologated in accordance with European standards, ensuring safe use, even in ski boots.

This flexibility enables users to enjoy the facilities freely, whether it be in winter on snowy slopes or in summer on open land.

We can fully customize the panels to better integrate them in your environment. The courses can include a variety of activities like cross-country skiing, the horse, the skater, the twist, the surf, and many more. Each module is designed to offer a unique, motivating experience while also promoting physical training.



ASO
FRANCE

Sports & Accessoires Outdoor



Our partner Aso France is renowned for the quality and durability of its products, thus providing an ongoing investment for your recreational location. By installing these fitness courses, you are enriching your site's provisions and meeting the needs of customers who are looking for new sporting and wellness activities.



leisure Toboggan activities



Toboggan runs

Design your custom toboggan spaces

We create unique, customizable toboggan spaces which are adapted to meet your needs, and which fit in with the specific environment of your location. From signage to decoration, including protection of your slopes, we manage the entire installation process for your project. Our theme-based runs are designed to fit in with your graphic universe, and provide immersive experiences with innovative sensory modules.



We provide a range of custom solutions which are suited to your landscape, taking into account the features of your space and your customers' expectations. Together, we can transform your toboggan runs into a place of discovery and pleasure for everyone!



Toboggan crash pad

Dimensions (mm)

Crash pad for sled trails

H x L x D	Mat.	Low-slip 	Low-slip 	Smooth cover 	
500 x 2500 x 500	PU	MAT866	MAT967	MAT552	REFM
500 x 2500 x 150	PU	MAT889	MAT989	MAT550	REFM
500 x 4000 x 150	PU	MAT890	MAT990	MAT551	REFM

Advantages

Toboggan crash pad

- 1 Easy to move
- 2 High wind resistance
- 3 Good useful life
- 4 Easy to store
- 5 Safety (shock absorption)
- 6 Standard furniture
- 7 Customizable furniture



PU foam
 PVC panel 630 gr/m²
 Option for customization
 Anti-slide PVC panel on snow
 Dimensions:
 H 2.50 m / 0.50 m or 2.50 m / 0.15 m

Toboggan



Toboggan

Plastic toboggan
Reinforced plastic brakes

Carbostar toboggan dimensions:
93x45x10 cm

LUGCAR

Maxi Carbostar toboggan
dimensions: 111x56x10 cm

LUGMAX



Advantages

Toboggan

- 1 Easy to move
- 3 Good useful life
- 4 Easy to store
- 6 Standard furniture



safety

competition

facilities



Toboggan

leisure

Fun coaster

New generation of Toboggan monorail

Monorail, simple, light, and so much more!

Designed to have no limitations, our monorail fits into the landscape perfectly, and its aluminum structure allows it to adapt to any terrain. Our design delivers a unique toboggan experience and a wide field of vision for unparalleled sensations.

Our concept provides the opportunity for infinite layouts with different types of run (spiral, twist, jumps, turns, or tunnels).



Technical characteristics

Rate	350 toboggans/h
Gradient	Of the run: 10% to 16% / Of the terrain: 15 to 40%
Speed	Max 40km/h
Layout	Closed circuit with integrated lift (customer in the toboggan) Option for boarding on upward or downward travel
Electrical requirements	Approx. 40 KW
Standards	Complies with ISO 19202 Summer toboggan runs
Operating staff	1 to 2 operators depending on numbers + ticket sales
Installation time	6 to 7 months
Accessibility	People weighing 20 to 160 kg
Minimum age	age 3, if accompanied; age 8 if unaccompanied
Number of users (per toboggan)	1 to 2 people (child or adult)



A carefully-designed, comfortable toboggan

Every element of our toboggan has been developed with one goal in mind: comfort for 2 people. Based on a new design which incorporates all ergonomic requirements, delivering unforgettable descents.

- Brake levers positioned on the outside to free up space in the center.
- Boarding and exiting on one level.
- Various options for customization and possible configuration.



A new all-weather attraction, using gravity to race down the slopes all year round. Endless enjoyment for one or two people!



The toboggan lift, a tried and tested technology

Built-in, powerful, and reliable. To simplify operations, we have developed a built-in toboggan lift, enabling operational performance to be maximized (rate of 700 people/h).

Each toboggan is equipped with a claw which allows it to connect to the lifting cable. In this case, we have benefitted from the extensive experience of MND ROPEWAYS in developing this new system.

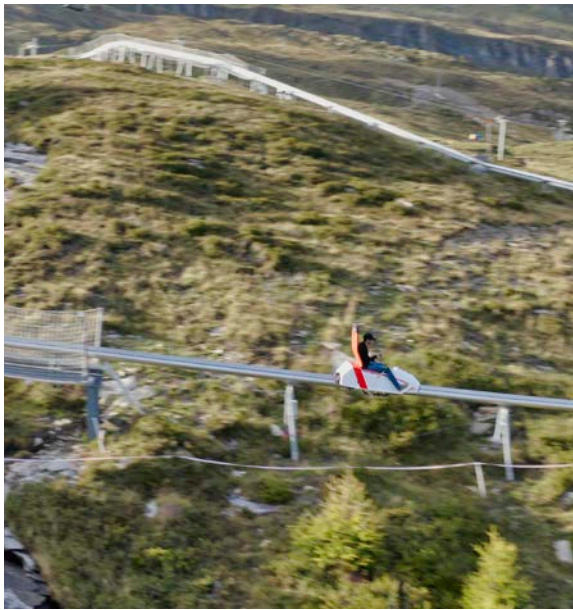

Presentation video

Possibilities, a new level of customization

- 1 Storage and maintenance facility
- 2 "Clip-on" weather-proofing
- 3 Snow removal blade
- 4 Toboggan lighting
- 5 Heated rail
- 6 Safety nets
- 7 Virtual reality
- 8 Slope lighting
- 9 Slope sound system
- 10 Video surveillance
- 11 Taking video or photos
- 12 Specific signage
- 13 Setting the scene and user experience
- 14 Toboggan customization
- 15 Choice of cover colors
- 16 Your logo or name
- 17 Choice of toboggan colors

Safety reaches new heights

Our FUN COASTER is one of the safest solutions on the market. All our elements provide an optimal level of performance both for users and operators.



Fall prevention net



Safety unit



Centrifugal brake
Safety belts



Collision
prevention



Tubing run

Tubing is tobogganing on a synthetic or snowy surface. The participant sits on a rubber ring and races down a slope. The slope is designed to bring together all the specific characteristics of the terrain, guaranteeing maximum sensation with curves, humps, and banked turns!

Tubing runs can be covered in snow or synthetic material. Synthetic slopes cannot be used when they are covered in snow, so the slopes which are to be used in the summer need to be installed separately from those which are to be used in the winter.

There are two types of rubber ring: rings with a hard base which are suitable for snow slopes and synthetic slopes, and flexible rings which are only suitable for sliding on snow. Different sizes of flexible ring are available to allow people to slide alone or with others.

Depending on the elevation, participants climb the slope on foot or on a mat.

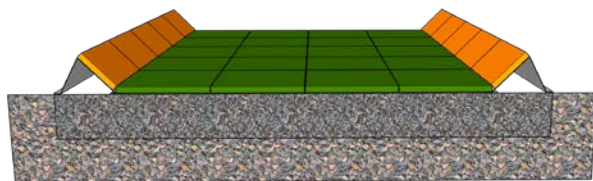
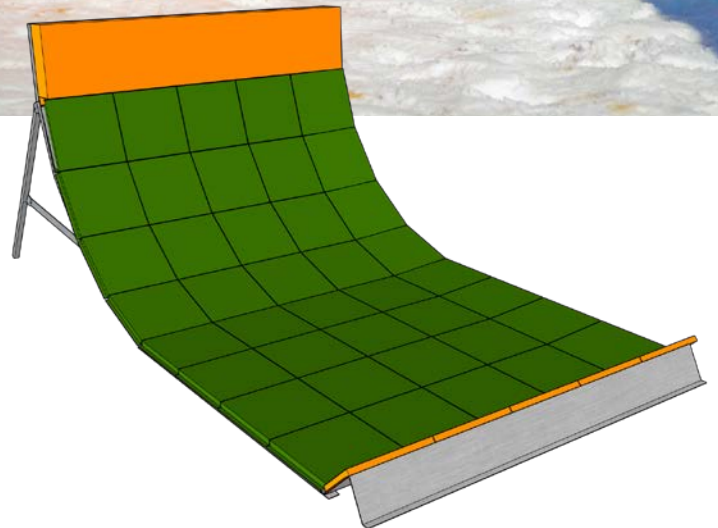



MBS partners with Geoplast to install synthetic slopes,

providing the best synthetic material for sliding: Geoski substrate sheets. This innovative sliding surface is designed to be made from HD PE, making it highly durable.

The sliding quality of synthetic slopes may vary depending on the temperature. To slide faster, a lubricant may be applied to the rings. To slide slower, rubber mats may be placed on the slope.

The slope is designed in line with the gradient and topography of the terrain. Therefore, it is necessary to prepare the terrain: earth-moving works to adapt the gradient and the base to prepare and drain the ground. Then, the metal course structure is installed on the prepared terrain.

Main characteristics of sheets:

- Sheet 40 x 40 x 2.7 cm (HDPE High Density Polyethylene)
- Easy to assemble
- Average weight: 5 kg/m²
- Margin for expansion 3-4 mm on each side
- Resistant to all weather conditions (UV, rain, snow, ice)
- Several colors available: red, green, blue, orange, and white

Conditions for slope use:

- Children under 5 cannot go tubing, except on slopes specifically reserved for them.
- Tubing is not recommended for pregnant women, or those who suffer from heart-related health issues, or back or neck problems.
- Synthetic tubing slopes may not be used in stormy conditions with thunder or lightning, or other dangerous weather conditions. In humid weather, the activity must be stopped.
- In the event of extremely cold or hot weather, synthetic slopes cannot be used as their sliding quality is too badly affected. The ideal temperature range for the correct use of tubes is 5° to 30°C.
- Nighttime operation is not authorized without lighting.

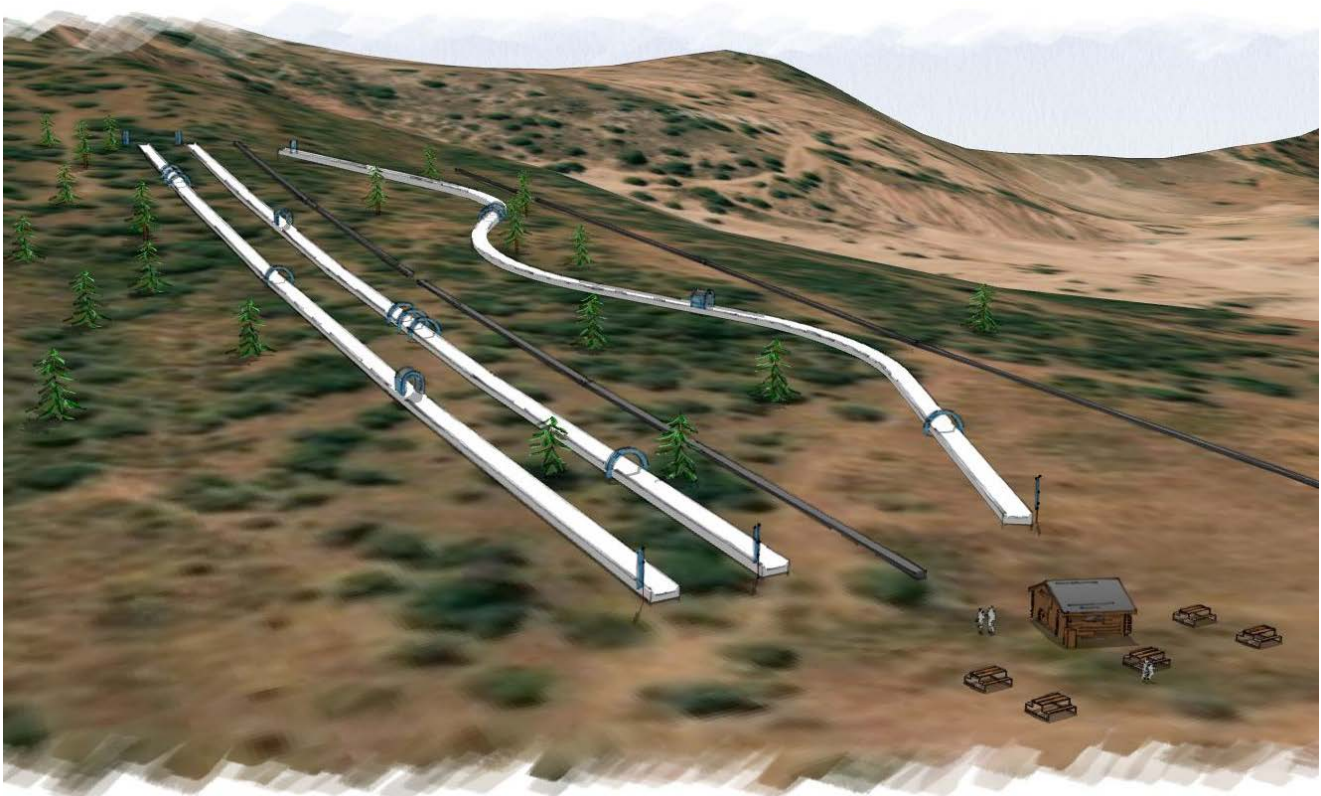



Ski activities

The Funrun range

has been developed with the aim of making skiing more fun for children aged 3 to 12.

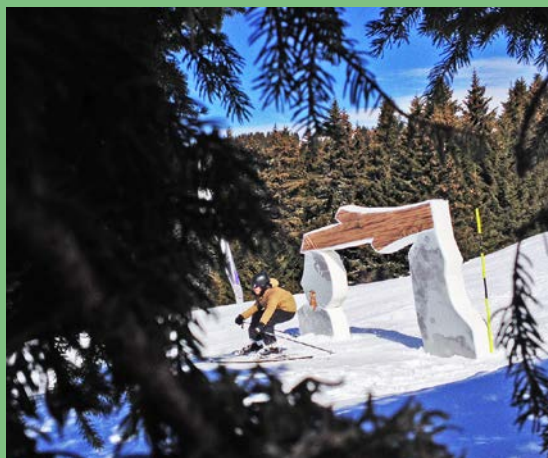

©MBS



Therefore, we have created different furniture with different interactions, diversifying the experience for young skiers.

©MBS



◆ MBS: BEST-FIT SOLUTIONS FOR YOUR EVERY NEED





**An experienced
technical
team,
*at your
service***

Where required, the furniture is covered with foam and tarpaulin, in order to ensure the participants' safety. We use waterproof foam to prevent ice from forming in the foam. You can print on the tarpaulin in order to customize the furniture.

Every ski resort has specific weather conditions, for which some of our products have been adapted, like the wooden arches or wooden gongs, to ensure that they can withstand strong gusts of wind.

From the design stage, where possible, we take into account limitations relating to the transport, use, and storage of the equipment.





leisure

ski activities

The Funrun range

Foam totem

FUN005

Steel and PC structure for greater safety
 Water-repellent foam to prevent ice from forming inside the structure
 Cover printed on both sides
 Dimensions: H 2.40 m / 0.90 m
 Custom shapes and printed finishes
 Base: steel sled base to be buried beneath the snow



This foam totem can be used to install a small totem sign in areas where space is at a premium. The chassis base is buried beneath the snow for added stability. The chassis features a height-adjustable design.

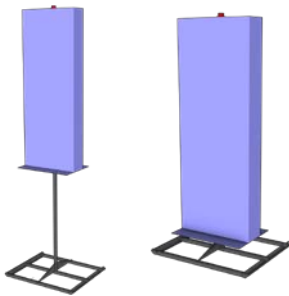

Advantages

Foam totem

- 1 Safety (shock absorption)
- 2 Standard furniture
- 3 Customizable furniture





Customize your signs



We custom produce all the necessary signs, banners, and flags for your routes. Get in touch!



Advantages Signs

- 1 Easy to move
- 2 High wind resistance
- 3 Good useful life
- 4 Easy to store
- 6 Safety
- 7 Standard furniture
- 8 Customizable furniture

Swivel arch

FUN004

Steel structure
 Water-repellent foam to prevent ice from forming inside the structure
 Cover printed on both sides
 Dimensions: H 2.40 m / 3.90 m
 Customizable printing
 Steel base to be buried



We have developed this swivel arch to be positioned on a narrow slope. It can be pivoted to allow snow groomers to pass freely.

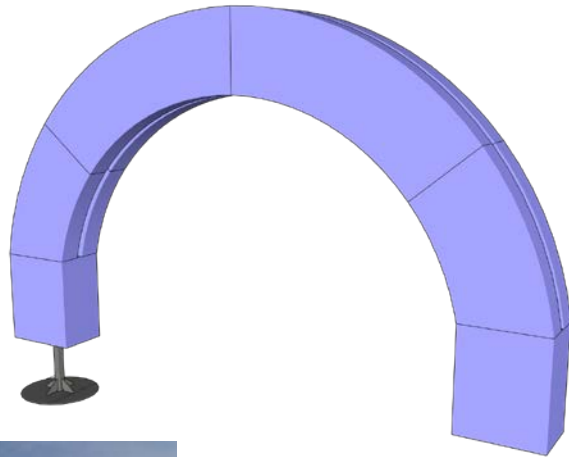

Advantages Swivel arch

- 1 Safety
- 2 Standard furniture
- 3 Customizable furniture



leisure

Wood arch

Acacia structure
 Customizable cylindrical protection
 crash pad
 Water-repellent foam wall and roll
 to prevent ice from forming inside
 the structure
 Customizable foam wall and gong
 Cover printed on both sides
 Can be disassembled into three
 parts for snow removal, transport,
 and storage
 Dimensions: H 2.80 m / 4 m



This arch is very stable and does not need to be anchored, for highly flexible furnishing.

FUN013

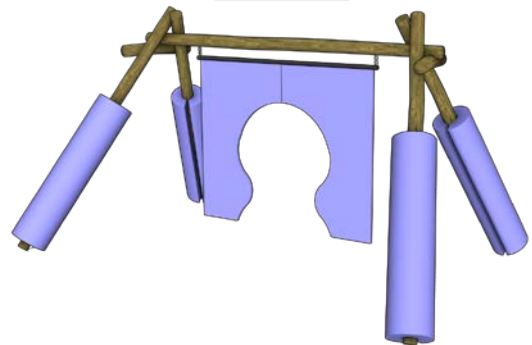

FUN014

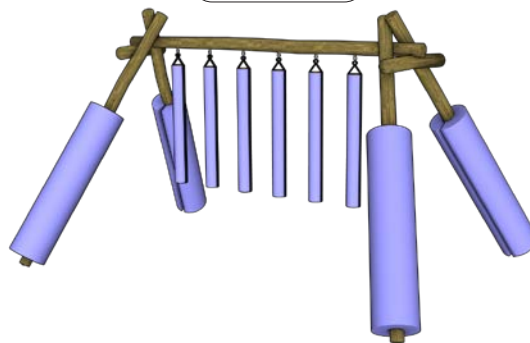

Advantages

Wood arch

- 1 High wind resistance
- 2 Good useful life
- 3 Environmentally-responsible materials
- 4 Standard furniture
- 5 Customizable furniture

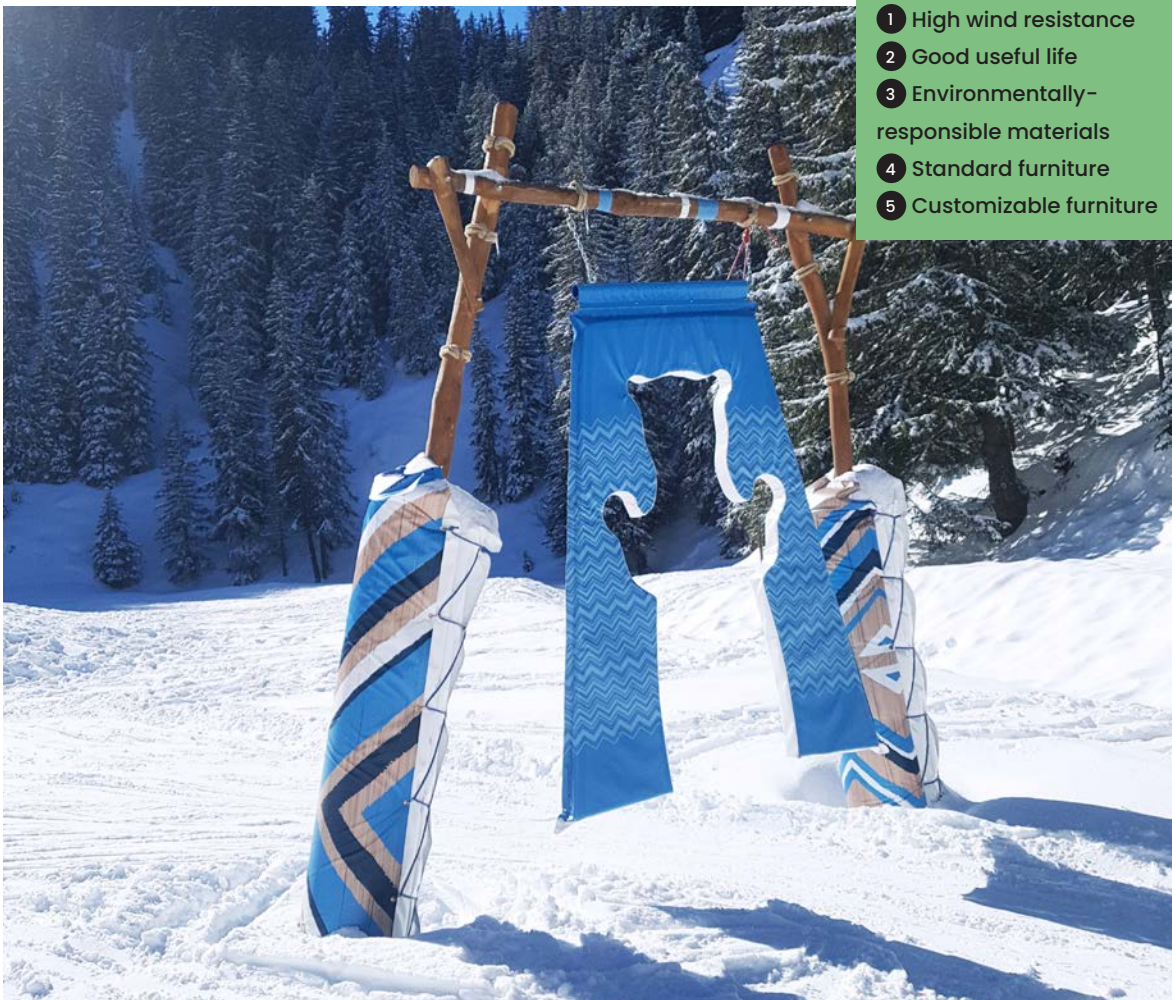



Advantages
Foam wall

- 1 High wind resistance
- 2 Good useful life
- 3 Easy to store
- 4 Safety (shock absorption)
- 5 Standard furniture
- 6 Customizable furniture

signage

safety

competition

Foam wall

Wall made of foam and tarpaulin suspended with a cable
 Water-repellent foam to prevent ice from forming inside the structure
 Cover printed on both sides
 Height-adjustable wall
 Dimensions of wall: section H 1.90 m / 1.10 m
 Custom shapes and printed finishes
 Option for avifauna signs



These foam walls hang on a cable, which enables them to be easily arranged. In addition, the length of the cable can be adjusted with a winch.

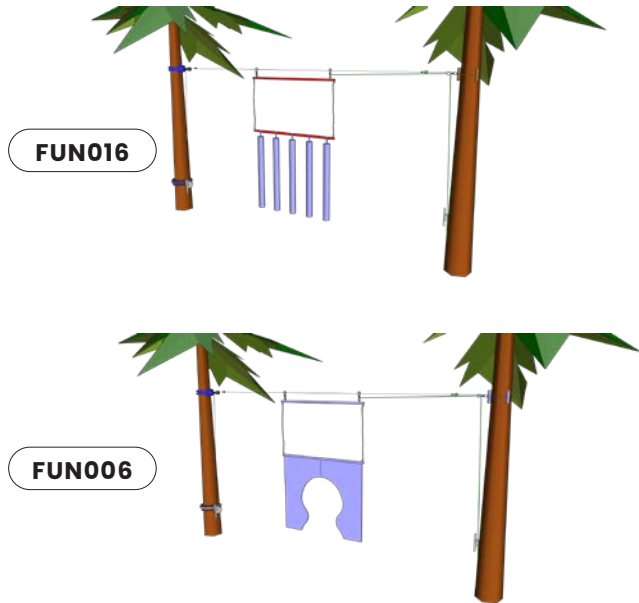

- Cable system
- FUN017**
- Fittings
- FUN018**

Tip from MBS expert:
 FUN006 and FUN016 are delivered without a cable system (FUN017) and fittings (FUN018)

leisure

facilities



leisure

Wood gong

Acacia structure
 Cylindrical protection crash pad,
 customizable tarpaulin
 Dimensions: H 4 m / 2 m
 Choice of base: steel plate to bury under
 the snow / concrete foundation
 Foam roll suspensions, customizable
 tarpaulin



This very stable gong can be fitted to a fixed or mobile mooring for highly flexible furnishing.

Roll for gong

FUN011

Tip from MBS expert:
 FUN015 and FUN007 are delivered without a roll (FUN011)

FUN015

FUN007

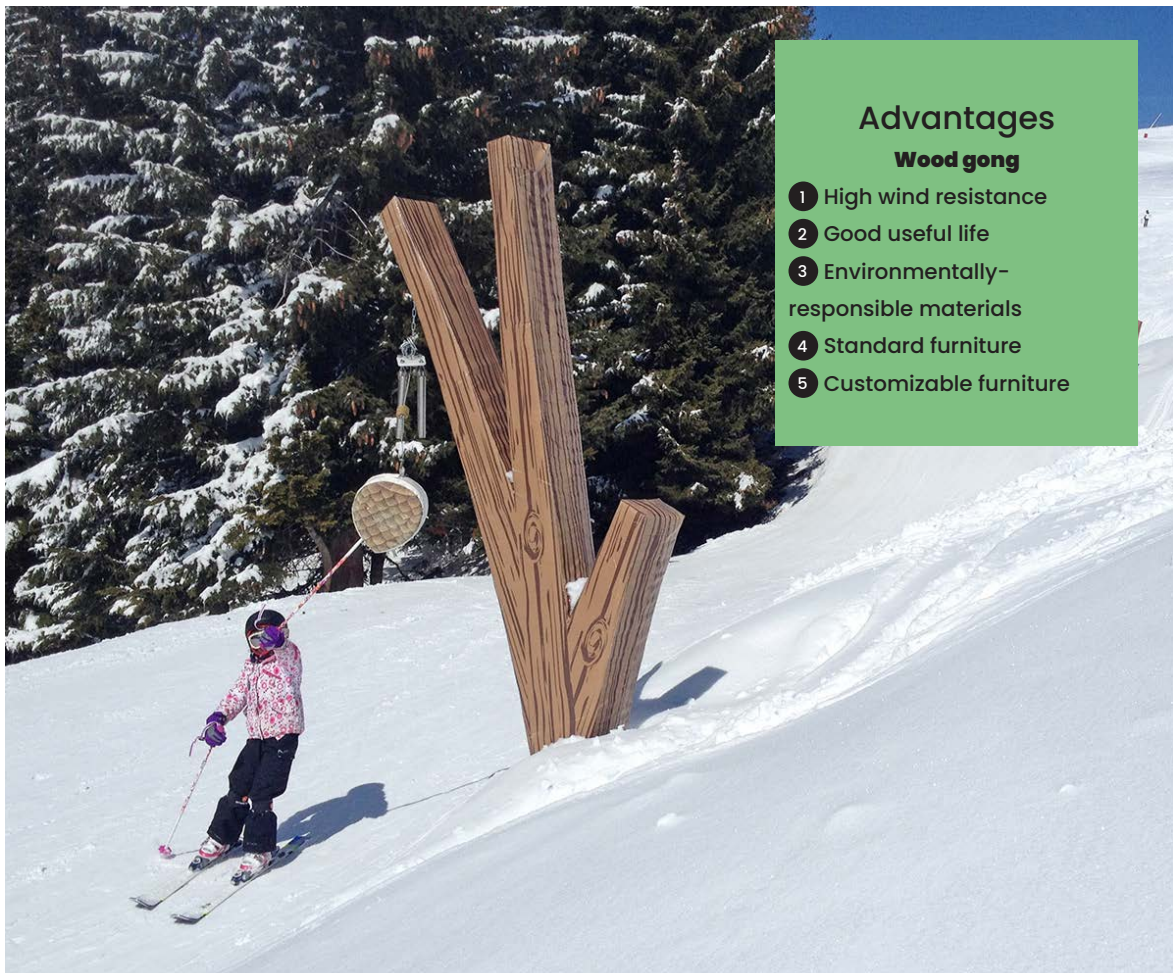
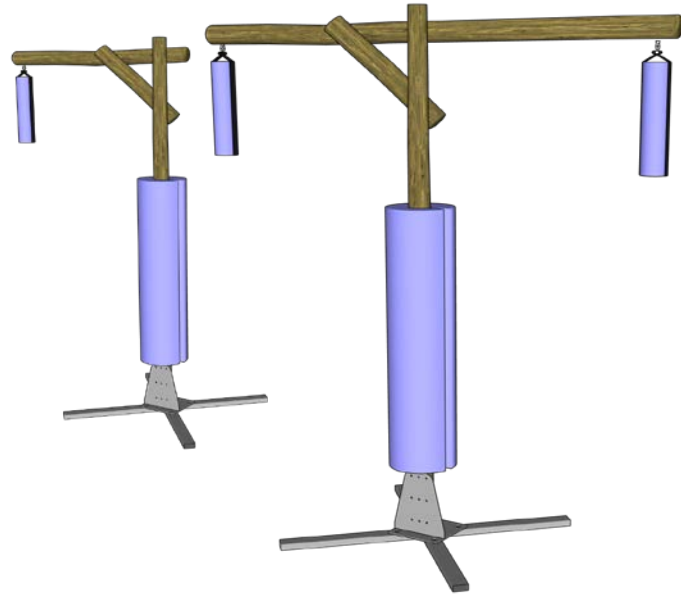

Advantages

Wood gong

- 1 High wind resistance
- 2 Good useful life
- 3 Environmentally-responsible materials
- 4 Standard furniture
- 5 Customizable furniture



Xylophone

FUN008

Steel and wood structure
 Steel runner to make it easy to move
 Dimensions: H 2.50 m / 2.50 m
 Option: with or without protection crash pad depending on installation
 Surface treatment: untreated, option for oil or paint



To make it easy to move and guarantee stability, this xylophone has been fixed to a steel chassis to be buried under the snow.

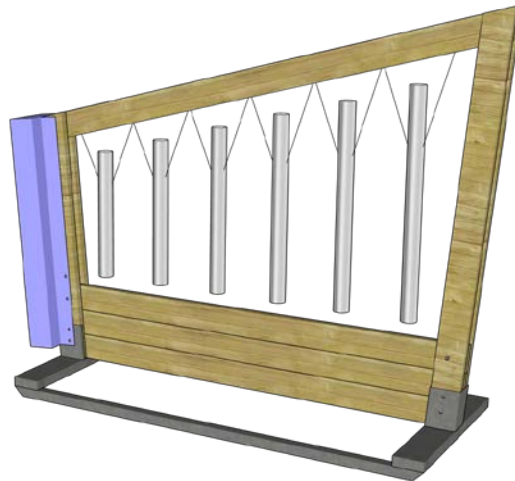

Advantages

Xylophone

- 1 High wind resistance
- 2 Good useful life
- 3 Environmentally-responsible materials
- 4 Standard furniture
- 5 Customizable furniture

Decoration

PC structure for greater safety
 Water-repellent foam to prevent ice from forming inside the structure

Cover printed on both sides
 Dimensions: H 2 m / 1.50 m
 Custom shapes and printed finishes
 Choice of base: base with plate / PE plate / brace / etc.

Advantages

Decoration

- 1 Easy to move
- 2 Good useful life
- 3 Safety (play area standard)
- 4 Customizable furniture





leisure

Swivel person

FUN019

PC structure for greater safety
 Water-repellent foam to prevent ice from forming inside the structure
 Cover printed on both sides
 Dimensions: H 1.50 m / 1.50 m
 Custom shapes and printed finishes
 Installation base not included
 Exclusive model for nurseries

Tip from MBS expert:
 plan to have a base (FUN010)
 for installing the person



Advantages

Swivel person

- 1 Easy to move
- 2 Easy to store
- 3 Safety (shock absorption)
- 4 Standard furniture
- 5 Customizable furniture

Slalom person

FUN020

PC structure for greater safety
 Water-repellent foam to prevent ice from forming inside the structure
 Cover printed on both sides
 Maximum dimensions: H 1.50 m / 1.20 m
 Custom shapes and printed finishes
 Installation base not included

Tip from MBS expert:
 plan to have a base (FUN010)
 for installing the person

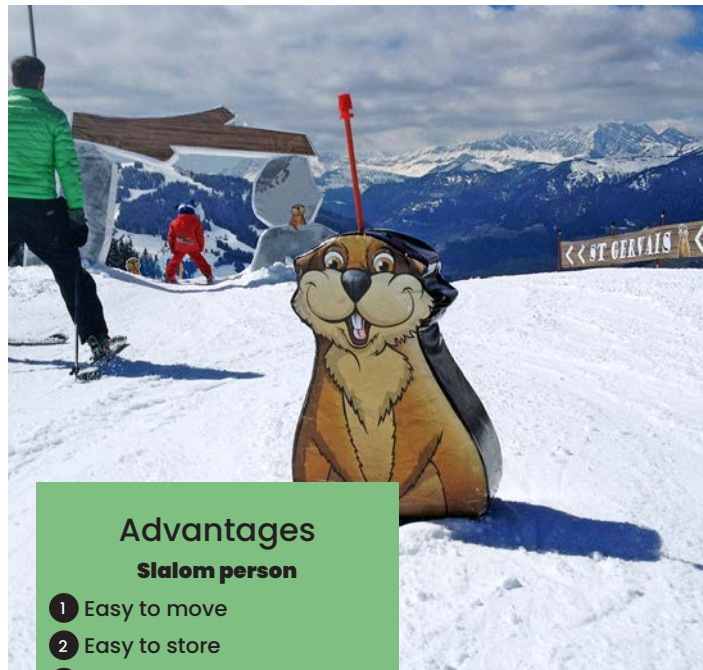

Advantages

Slalom person

- 1 Easy to move
- 2 Easy to store
- 3 Safety (shock absorption)
- 4 Standard furniture
- 5 Customizable furniture



Soft Box & Wood Box

Soft Box



Foam and tarpaulin structure
 Polymer sliding surface (white)
 Dimensions: H 0.50 m / 0.60 m / 4 m
 Option for customizable tarpaulin color
 Standard colors Red / Orange / Green / Blue

Advantages

- 1 High wind resistance
- 2 Safety (shock absorption)
- 3 Standard furniture

⊕ *The chassis of these boxes is soft. If the child falls, some of the impact is absorbed. Therefore, this type of module is perfectly suited to beginners.*

Wood box



Larch structure
 Polymer sliding surface (white)
 Approximate dimensions: H 0.50 m, W 0.60 m, L 4.00 m
 Weight: approx. 80 kg for the heaviest

Advantages

- 1 High wind resistance
- 2 Good useful life
- 3 Standard furniture

⊕ *These wood boxes are strong and light. The sliding surface does not have any screws or bolts on it, in order to guarantee participants' safety.*

Mini wood box



Larch structure
 Polymer sliding surface (white)
 Dimensions: H 0.20 m / 0.60 m / 2 m

Advantages

- 1 Easy to move
- 2 High wind resistance
- 3 Good useful life
- 4 Easy to store
- 5 Standard furniture

⊕ *These miniature boxes are suitable for young children to enable them to discover the sliding sensation for the first time.*

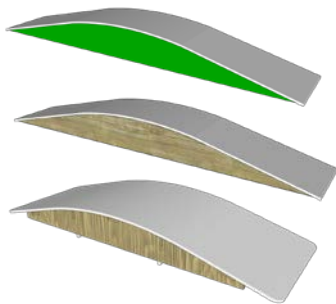

Rainbow

Soft box	Wood box	Mini box
FUN002	FUN037	FUN031

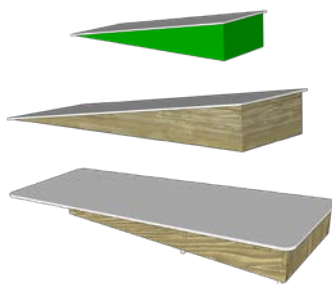

Kicker

Soft box	Wood box	Mini box
FUN022	FUN036	FUN030

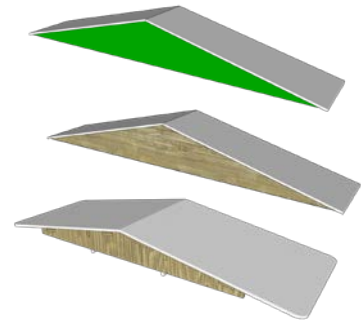

Ascent Descent

Soft box	Wood box	Mini box
FUN001	FUN038	FUN032

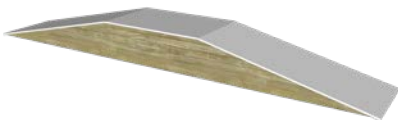

Ascent Flat Descent

Wood box
FUN039
Dimensions H x D x L

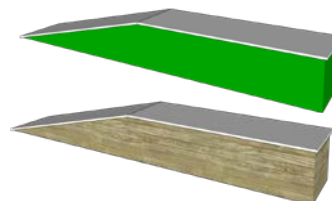

Ascent Flat

Soft box	Wood box
FUN024	FUN040

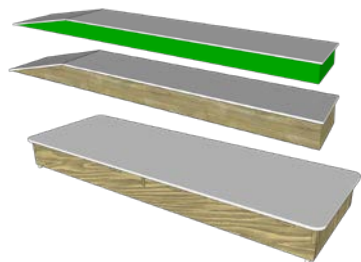

Flat

Soft box	Wood box	Mini box
FUN025	FUN041	FUN035
Dimensions H x D x L	Dimensions H x D x L	Dimensions H x D x L

signage

safety

competition

leisure

facilities



leisure

Recreational equipment

Polymer barriers

Polymer barrier 2 m x 1 m - Blue
Other color options, depending on quantity

BAR124



Hoops

Made of polycarbonate. Can be disassembled for storage.
2 m x 2.10 m

MP3871144



MP3871159



MP3871145



MP3871158



MP3870815



MP3871176



Hoop bell

MOPC00036



Foam figurines

Figurines 100 cm x 55 cm - "Piou-piou" images



255128



255129



255130



255131



255132



Walking mat

Installation kit

Anchoring pole with elastic for walking mat

Unit **252681**

Set of 6 **252683**

Set of 8 **252684**



Openwork mesh mat with panel border, fastening eyelets, and attaching sticks

Dimensions		Weight	Branding		ID	
L	H	Kg	YES	NO	●	●
6000	700	1.3		+	MP3870787	MP3870831
1200	700	2.5		+	MP3870789	MP3870832

Thick walking mat

Thickness 12 mm
Length 5 m
Width 45 cm
Weight 11 kg

MP3870788 ●

MP3870786 ●



Marker cones

TO be placed on the snow
Ø 18 cm - Height 7 cm
Delivered with storage tube.
Enables automatic collection without bending down.

Assortment of 48 cones: **MP3870798**

- + 12 red
- + 12 blue
- + 12 green
- + 12 orange

3 storage tubes **MP3870797**



Hoops

For storage, transporting racing bibs, and guiding children.
Hoops with locking clip.

MP3871382



signage

safety

competition

leisure

facilities



leisure

Recreational equipment

Beginner poles

Fully flexible, 68 cm above snow - Ø 5 cm



MP3871288



MP3871289



MP3871290

Marking poles

Height 75 cm x Ø 15 cm

MP3876000

34 red/33 blue/33 green
Minimum 100 units



MP3876000R

Batch of 100 red



MP3876000B

Batch of 100 blue



MP3876000V

Batch of 100 green

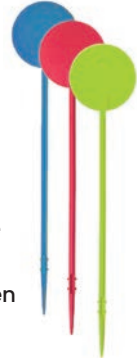

Soft cones

Orange only

Height 50 cm - weight 1100 g

MP3871380



Small cones

Height 18 cm - weight 230 g

MP3870567



MP3870566



MP3870565



MP3870564



Mushroom marking cone with base

For perfectly anchored cones.

MP3870651



MP3870650



MP3870652



Recreational equipment



Magic stairs

STAIRS ASCENT

Unfold the colored tubes perpendicular to the axis of the gradient.

Hammer anchoring poles into the 4 corners.

Your staircase ascent training workshop is ready.

Width 2.10 m - Length 4 m

Yellow / Red

MP3870624

Colors may vary depending on stock.

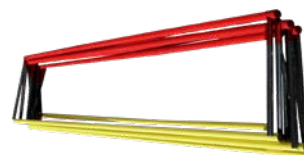

Red Magic Route

Polycarbonate tubes and anchoring poles linked with an elastic.

Easily folded for storage. Stays in place during exercises.

Quick to install.

For multiplying the descent exercises for learning turns and straight line skiing.

10 m in 10 tubes of 1 m:

MP3870670

20 m in 9 tubes of 2.10 m:

MP3870656

Colors may vary depending on stock.

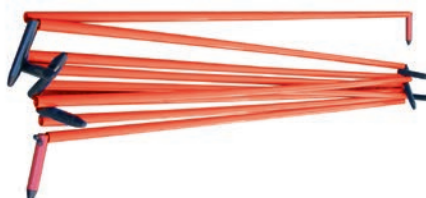

Nursery enclosure



Enclosure made of openwork mesh installed on fiberglass poles.

Colors: red or blue

Customizable with texts and logos

**QUOTATIONS AVAILABLE FOR
OTHER DIMENSIONS AND EQUIPMENT**

10 m x 0.75 m Piou Piou image with fiberglass poles.

BAN524

signage

safety

competition

leisure

facilities

1988



**Facili-
ties**



Mats	P. 202
Anchoring	P. 204
Snow fence nets	P. 206
Snow barriers	P. 207
Road poles	P. 208
Accessories	P. 209

Mats

Transport mat

Solution for transporting people winter/summer

BENEFIT#1

The simplest system for transporting people

Can be used by:

- Skiers
- Pedestrians
- Toboggans
- Tubing
- Strollers
- Wheelchairs
- Bicycles

TECHNICAL CHARACTERISTICS

- Patented sliding surface with gratings
- Useful mat widths: 600, 900 or 1200 mm
- Speed can be adjusted from 0.2 to 0.7 m/s (optional for up to 1.2 m/s)
- Rate of up to 4320 p/h
- Built-in electrical cabinet with speed regulator
- Linear and modular elements which are 3 meters long
- Hydraulic tension
- Control touch screen
- Complies with EN15700 and ANSI B77

OPTIONS

- Automatic restart after stoppage (cell, trap)
- Remote console
- One- or two-sided exit at 0.9 m/s
- Straight exit at 1.2 m/s with double safety trap
- Station heating system before and/or after
- Mat with non-slip surface for maximum adhesion
- Manual switch on for mats of up to 4 kW
- PVC panel or galvanized steel plates for side covers
- PVC panel with seasonal cover
- Motorized brush for additional strip cleaning
- Presence-sensing radar for starting up the device
- Remote maintenance assistance
- Gallery and associated options (LED lighting, customization, etc.)



Operational advantages

Inherent defrosting

Due to the gratings which make up the sliding surface

The holes in the sliding surface gratings drain the water and condensation present between the internal surface of the mat and the sliding surface, preventing ice from forming, as this makes it difficult to start the mat the next day.

Simple, fast installation

Due to pre-assembly in the workshop

The majority of the components are pre-assembled in the workshop to allow the mat to be tested before it is shipped, which makes on-site assembly quicker and easier.

BENEFIT#2

Energy savings and easy start-up thanks to MND gratings

Our solution, which uses gratings with holes, reduces friction and saves a significant amount of energy. By preventing ice from forming, this patented solution also allows the mat to be started up quickly, and guarantees that it will stay open in extreme environmental conditions.





SPECIFIC CHARACTERISTICS AND ADVANTAGES OF THE SOLUTION

- The motor station has been designed to ensure maximum safety for users and operators, but also to simplify access to all elements for easy, safe maintenance
- Coded safety sensors to prevent the risk of accidental exclusion
- Simplified installation on site, due to pre-assembly in the factory
- Maintenance facilitated by operator, as hydraulic, electrical, and mechanical components can be accessed from above
- Extremely safe maintenance due to remote controls
- Honeycomb strip which is strong and economical
- Highly-adherent strip to reduce the risk of skiers sliding
- Remote assistance, available from the automatic controls, to easily resolve any operational problems and reduce the costs of any work or maintenance.
- After-sales service during seasons when it is in use to guarantee optimal operation



ZOOM#1

Side exit

The side exit reduces problems caused by snowfall during operation: all the snow is carried by the strip instead of accumulating on the safety trap until it hides the sensors and stops the mat. It is moved all the way into the ditch under the station, or melted by the heating system.



ZOOM#2

The gallery: guaranteed ease of use and comfort

The gallery significantly reduces snow removal operations during winter, while also sheltering customers. MND galleries fit in perfectly with their environment, and provide multiple options for improving the customer experience (lighting, customization, etc.).



Anchoring

Winch machine clamping

Raised anchoring: tripods

RAISED ATTACHMENT = SAVINGS

Increased useful life of cable
Option to work on lots of slopes from the same anchor point

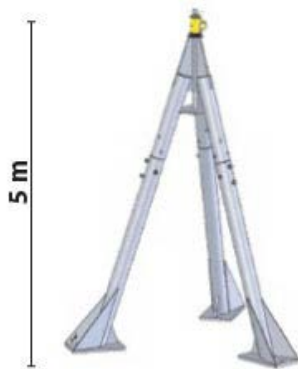

ANC135

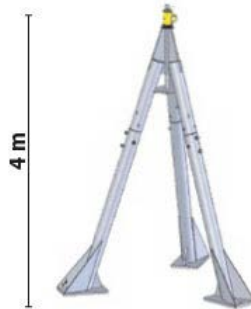

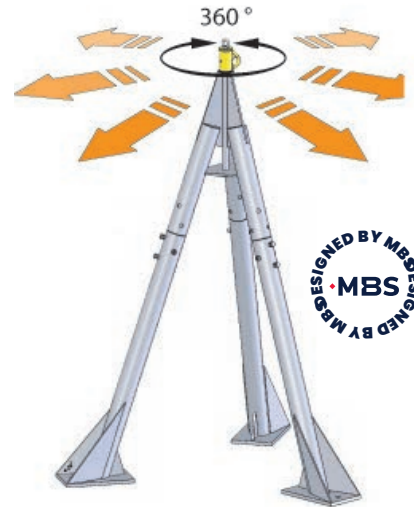

ANC134



GALVANIZED STEEL TRIPOD
Thickness 5 mm Ø 139 mm

Pre-formed mats for tripods

Dimensions (mm)		Pre-formed mats for tripods		
h	Ø int	Mat.	Low-slip	Low-slip
2000	150	PU	 MAT851	 MAT951



Fittings

SOFT GROUND

Plan to have 3 parts for 1 Tripod
COMPLETE MOORING



AMMT00028

ROCK

GEWI BAR - Ø 32 mm - L 3m

250564

GEWI BAR - Ø 32 mm per linear meter - L to be specified

ANC140

NUT Ø 32 mm

ANC141





Winch machine clamping



ANC107

COMPLETE MOORING ANCHORING
 Delivered with a 2 m chain sling for burying, a 3 m above ground traction chain sling with clevis and ring, sling support tube, and support clamp with tubing for installing in the ground.

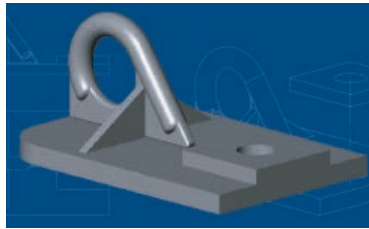

ANC139

ANCHORING TO THE GROUND
 Galvanized steel plate



Accessories



● Chain Hanging Pole with sling support hook (sling not included) ↔ 3 m **ANC142**

● Single ring WLL 5000 kg **ANC143**

● Lifting chain made of COROLIM (linear meter) WLL 5300 kg Ø13 mm **ANC144**

● Connecting mesh WLL 5000 kg **ANC145**

● Pointed base **PIQ154**



Return pulley WLL 5000 kg **ANC146**



Sealing resin 1 kg 7 kg **ANC110**
ANC147



Complete 2-line cable sling ↔ 3 m **ANC108**



Complete chain sling 2 m **ANC113**
 3 m **ANC109**
 5 m **ANC114**
 8 m **ANC115**

Snow fence nets

The MBS snow fence net creates an artificial barrier against the snow, stopping it by creating a drift in front of the net. This enables a large amount of snow to accumulate, making it easier to ensure snow cover on the ski slopes and set up snow schools.

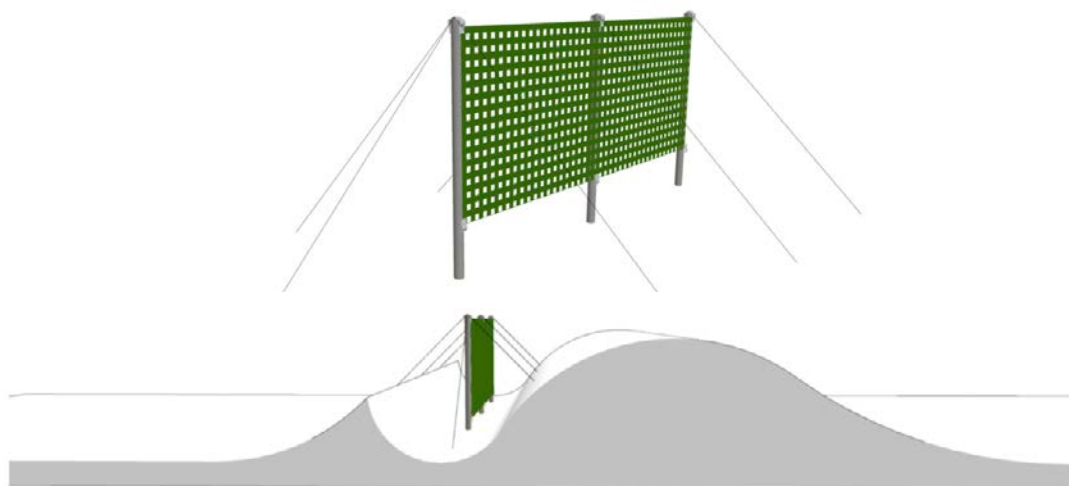

Full height of the solution	Net height	Length	Number of pegs	Number of slings and ground poles	ID
1.80m	1.50m	24 m	7	18 large slings + ground poles	FIL251
1.80m	1.50m	48 m	13	34 large slings + ground poles	FIL252
1.30m	1.00m	25 m	6	14 small slings + ground poles	FIL247
1.30m	1.00m	50 m	11	26 small slings + ground poles	FIL248

Net only

Highly resistant polyester net with green PVC coating

Net not compatible with attached spare parts (custom assembly).

To order

Height	Length	ID
1 m	100 m	FIL685



Spare parts

Full height of the solution	ID
1.5 m pole for snow fence net	256173
2 m pole for snow fence net	254419
Ground pole for snow fence net	254420
Large sling	ANC421
Small sling	254421



Snow barriers

The MBS snow barrier creates an artificial barrier against the snow, stopping it by creating a drift in front of the barrier. This enables a large amount of snow to accumulate, making it easier to ensure snow cover on the ski slopes and set up snow schools.

The snow barrier is a standardized product (NF P 95-305) from December 1992 with a certified system.

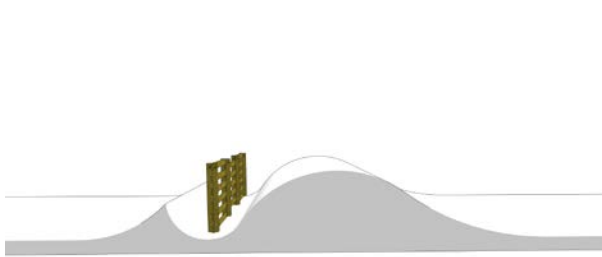

A correctly-installed snow barrier successfully accumulates snow from a distance 20 times greater than its height. In order to enable the barrier to be maximally efficient, it is recommended to install modules which are at least 20 times as long as they are tall. The specific snow barriers provided have buried struts, enabling the snow to be moved after installation.

Exposed struts

Exposed struts



Comprehensive solutions

Snow barriers are sold per linear meter (LM)
Material: Autoclave treated Scotch pine Class 4

Struts	Full height of the solution	ID
Buried	2.00 m	BAR130
Buried	1.50 m	BAR129
Exposed	2.00 m	BAR132
Exposed	1.50 m	BAR131



Road pole



Snow removal levels

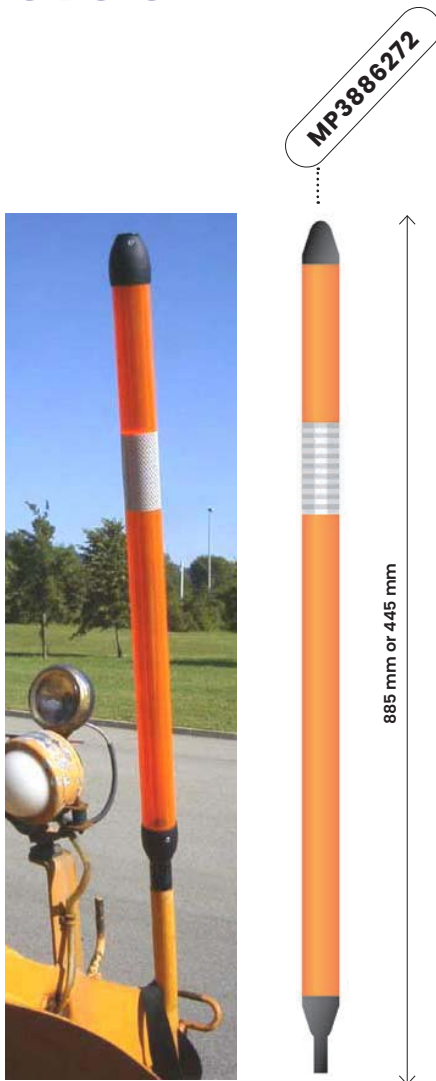

ID	Ø	L
MP3848271	48	850
MP3886271	30	850
MP3886272	30	445

Snow removal blade level indicator made of Ø 30 or Ø 48 mm lumifog polycarbonate - L 850 mm or L 445 mm with 10 cm reflective strip class 2 and polymer hinge.

Road poles

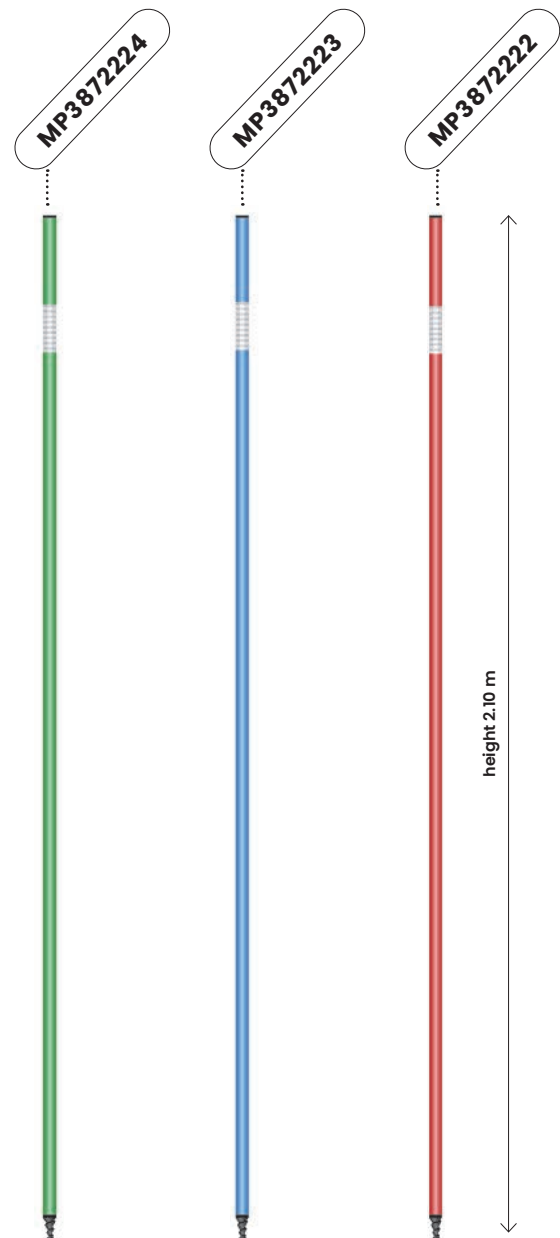

Ø25

Ø25 polycarbonate road poles - L 2.10 m, installed with screw tip and 10 cm reflective strip class 2. Available in 3 colors.



Accessories

Snow rake

DIV106

- Laser-cut stainless steel base, 600 mm wide
- Aluminum shaft, overall tool length 1800 mm
- Safety handle, width 200 mm (2 hands, side by side)
- Weight 4.1 kg



Steel maintenance rake

DIV105



Resin scoop

DIV104

- Width: 50 cm
- Length: 59 cm
- Weight: 4.9 kg
- Steel ergonomic handle 142 cm
- Shovel with wear strip, 35-liter capacity



Steel scoop

DIV103

- Width: 64 cm
- Length: 84 cm
- Weight: 10.5 kg
- Steel ergonomic handle 103 cm
- Shovel with wear strip and strengthening ribs, high capacity



Snow shovel

DIV101

- Aluminum blade
- Wood shaft
- 1200 mm



Snow shovel

DIV102

- Aluminum blade
- Wood shaft
- Safety handle, width 340 mm, length 750 mm

Other nets

Polyamide landing net

Standard NF EN 1263-1

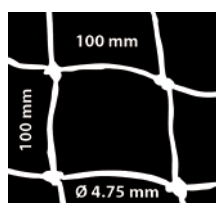

White PA WOVEN NETS

100 mm Ø 4.75 mm mesh with Ø 12 mm polyamide reinforcement around the perimeter
Price upon request, depending on dimensions

FIL144



ONE PARTNER
MANY SOLUTIONS

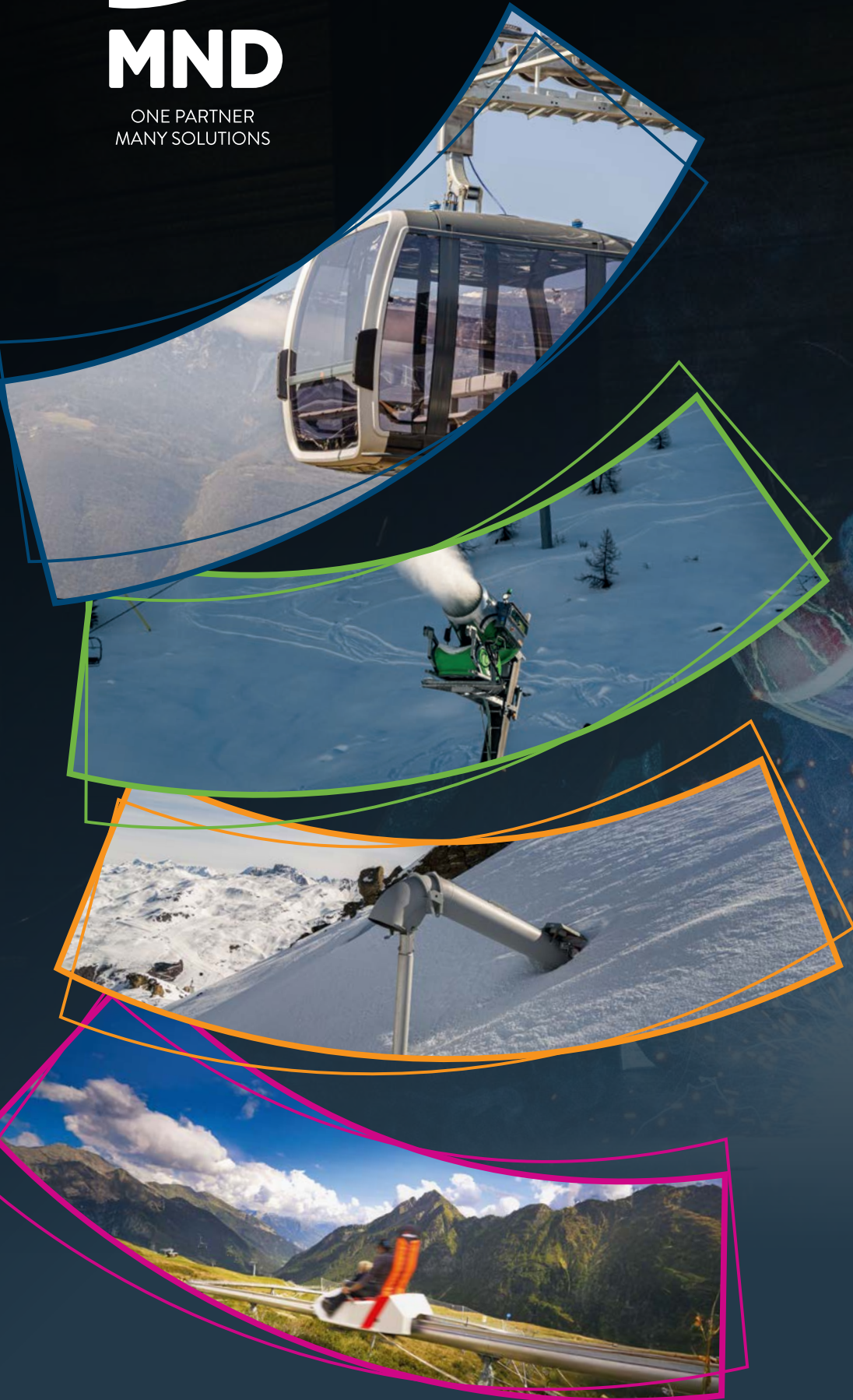

Follow us     

EXPERTISE
Made in the Alps

ONE PARTNER MANY SOLUTIONS



OVERALL PROVISION

As a leading industrial group for furnishing mountain spaces, MND operates on an international level.

Strategically, we made a simple choice: **“One partner, many solutions”**.

“One partner” because the complexity of furnishing projects requires fast, efficient, coherent operations, seamless synergy across job roles, and a shared goal to work together towards a harmonious, perfectly-integrated result.

“Many solutions” because all situations are different, and require different types of high-level expertise, based on our excellent industrial performance.



Find out more about MND

4 AREAS OF WORK

ROPEWAYS, SNOW, SAFETY, LEISURE: 4 sectors, and 4 areas in which MND has world-leading expertise.

Products which are designed and manufactured in the Alps, a leading location in relation to mountain furnishing, where the future of our industry is being built. Teams in the field, grounded in reality.

Products installed on all the planet's major mountain ranges, and an innovation which is even becoming essential for urban transport solutions.

KNOW-HOW

Our heart for the profession. The women and men of MND are our most precious resource. Knowing is one thing, and we do have some of the leading experts in each of our areas of work.

But doing is essential. Our teams unveil their operational excellence when working in the field.

We study, we manufacture, we install, and we maintain; by your side, all the way.



MBS

MOUNTAIN BASE SAFETY



Mbs.fr

📍 ZAC Porte de Tarentaise
504 Route des Marais
73790 Tours en Savoie

✉ contact@mbs.fr

☎ +33 4 79 39 98 98